

TM 11-6625-2948-24P

TECHNICAL MANUAL

ORGANIZATIONAL, DIRECT SUPPORT AND GENERAL SUPPORT
MAINTENANCE REPAIR PARTS AND SPECIAL TOOLS LISTS
(INCLUDING DEPOT MAINTENANCE REPAIR PARTS AND SPECIAL TOOLS)
FOR
SIGNAL GENERATOR AN/URM-206
(NSN6625-01-077-8503)

HEADQUARTERS, DEPARTMENT OF THE ARMY

2 MAY 1985

TECHNICAL MANUAL }
 No. 11-6625-2948-24P }

HEADQUARTERS
 DEPARTMENT OF THE ARMY
 WASHINGTON, DC, 2 May 1985

**ORGANIZATIONAL, DIRECT SUPPORT AND GENERAL SUPPORT
 MAINTENANCE REPAIR PARTS AND SPECIAL TOOLS LISTS
 (INCLUDING DEPOT MAINTENANCE REPAIR PARTS AND SPECIAL TOOLS)
 FOR
 SIGNAL GENERATOR AN/URM-206
 (NSN 6625-01-077-8503)
 Current as of 30 January 1985**

REPORTING ERRORS AND RECOMMENDING IMPROVEMENTS

You can help improve this manual. If you find any mistakes or if you know of a way to improve the procedures, please let us know. Mail your letter, DA Form 2028 (Recommended Changes to Publications and Blank Forms), or DA Form 2028-2 located in back of this manual direct to: Commander, US Army Communications-Electronics Command and Fort Monmouth, ATTN: AMSEL-ME-MP, Fort Monmouth, NJ 07703-5007.

In either case, a reply will be furnished direct to you.

Table of Contents

	Page	Illus Figure
SECTION I Introduction	1	
II. Repair Parts List	1	
GROUP 00 Signal Generator AN/URM-206	1-1	1
Signal Generator AN/URM-206, Front View.	2-1	2
Signal Generator AN/URM-206, Rear View.	2A-1	2A
01 Signal Generator SG-1145/URM		
Signal Generator SG-1145/URM, Top View.	3-1	3
Signal Generator SG-1145/URM, Side View	4-1	4
AC Box Assembly	5-1	5
0101 Pushbutton Board Assembly D161469.	6-1	6
Pushbutton Board Assembly D161606-2, Top View	6A-1	6A
Pushbutton Board Assembly D161469, Bottom View	7-1	7
Pushbutton Board Assembly, B-161606-2, Serial No. 5-201B thru 5-511B, Bottom View	7A-1	7A
0102 High Voltage Control Board C161321	8-1	8
0103 High Voltage Box D161309	9-1	9
010301 High Voltage General Component Assembly	10-1	10
0104 Master Oscillator Assembly.	11-1	11
02 Modulator MD-1075/URM		
Modulator MD-1075/URM, Top View	12-1	12
Modulator Board Assembly	13-1	13
Modulator Board Assembly, Resistors and Capacitors	14-1	14
SECTION III. Special Tools List (Not applicable)		
IV. National Stock Number and Part Number Index	I-1	

*This manual supersedes TM 11-6625-2948-24P, 5 June 1981.

SECTION I

INTRODUCTION

1. Scope

This manual lists and authorizes spares and repair parts; special tools; special test, measurement, and diagnostic equipment (TMDE); and other special support equipment required for performance of organizational, direct support, and general support maintenance of the AN/URM-206. It authorizes the requisitioning, issue, and disposition of spares, repair parts and special tools as indicated by the source, maintenance and recoverability (SMR) codes.

2. General

This Repair Parts and Special Tools List is divided into the following sections:

a. Section II. Repair Parts List. A list of spares and repair parts authorized by this RPSTL for use in the performance of maintenance. The list also includes parts which must be removed for replacement of the authorized parts. Parts lists are composed of functional groups in ascending numeric sequence, with the parts in each group listed in ascending item number sequence. Figure numbers are listed directly beneath the group header.

b. Section III. Special Tools List. Not applicable.

c. Section IV. National Stock Number and Part Number Index. A list, in National item identification number (NIIN) sequence, of all National stock numbered items appearing in the listing, followed by a list in alphameric sequence of all part numbers appearing in the listings. National stock numbers and part numbers are cross-referenced to each illustration figure and item number appearance.

3. Explanation of Columns (Section II and III)

a. Item No. (Column (1)). Indicates the number used to identify items called out in the illustration.

b. SMR Code (Column (2)). The source, maintenance, and recoverability (SMR) code is a five-position code containing supply/requisitioning information, maintenance category authorization criteria, and disposition instruction, as shown in the following breakout:

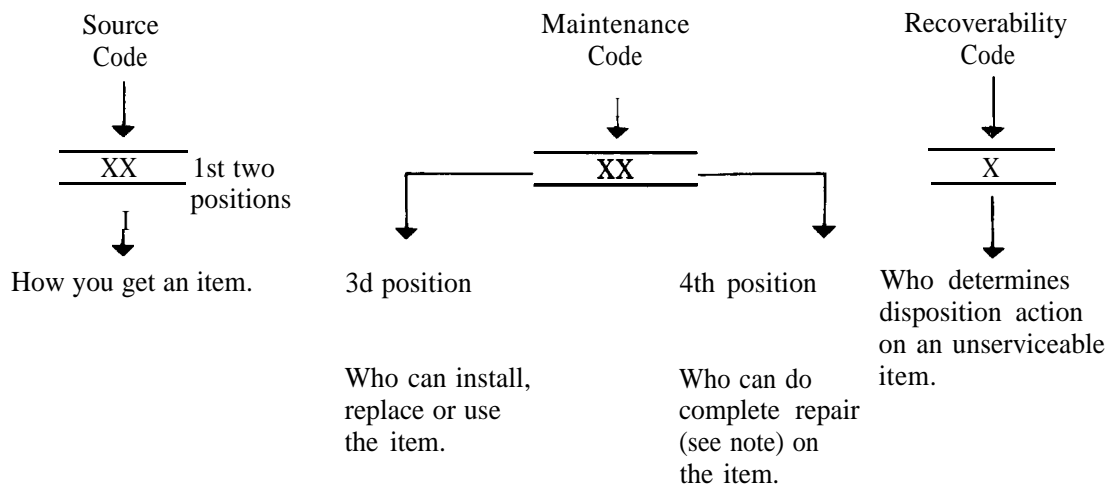

NOTE

Complete repair: Maintenance capacity, capability, and authority to perform all corrective maintenance tasks of the "Repair" function in a use/user environment in order to restore serviceability to a failed item.

(1) Source code. The source code tells you how to get an item needed for maintenance, repair, or overhaul of an end item/equipment. Explanations of source codes follows:

Code	Explanation
PA PB PC PD PE PF PG	<p>Stocked items; use the applicable NSN to request/requisition items with these source codes. They are authorized to the category indicated by the code entered in the third position of the SMR code.</p> <p style="text-align: center;">NOTE Items coded PC are subject to deterioration.</p>
KD KF KB	<p>Items with these codes are not to be requested/requisitioned individually. They are part of a kit which is authorized to the maintenance category indicated in the third position of the SMR code. The complete kit must be requisitioned and applied,</p>

MO-Made at org/AVUM category MF-Made at DS/AVUM category MH-Made at GS category ML-Made at Specialized Repair Activity (SRA) MD-Made Depot	<p>Items with these codes are not to be requested/requisitioned individually. They must be made from bulk material which is identified by the part number in the description and usable on code (UOC) column and listed in the Bulk Material group of the repair parts list. If the item is authorized to you by the third position code of the SMR code, but the source code indicates it is made at a higher category, order the item from the higher category of maintenance.</p>
AO-Assembled by org/AVUM category AF-Assembled by DS/AVIM category AH-Assembled by GS category AL-Assembled by SRA AD-Assembled by Depot	<p>Items with these codes are not to be requested/requisitioned individually. The parts that make up the assembled item must be requisitioned or fabricated and assembled at the category of maintenance indicated by the source code. If the disposition code of the SMR code authorizes you to replace the item, but the source code indicates the item is assembled at a higher category, order the item from the higher category of maintenance,</p>

Code	Explanation
XA-	Do not requisition an "XA" coded item. Order its next higher assembly.
XB-	If an "XB" item is not available from salvage, order it using the FSCM and part number given.
XC-	Installation drawing, diagram, instruction sheet, field service drawing, that is identified by manufacturers part number.
XD-	Item is not stocked. Order an "XD" coded item through normal supply channels using the FSCM and part number given, if no NSN is available.

NOTE

Cannibalization or controlled exchange, when authorized, may be used as a source of supply for items with the above source codes, except for those source coded "XA" or those aircraft support items restricted by requirements of AR 750-1.

(2) *Maintenance code.* Maintenance codes tell you the category of maintenance authorized to USE and REPAIR support items. The maintenance codes are entered in the third and fourth positions of the SMR code as follows:

- (a) The maintenance code entered in the third position tells you the lowest maintenance category authorized

to remove, replace, and use an item. The maintenance code entered in the third position will indicate authorization to one of the following categories of maintenance.

<i>Code</i>	<i>Application/Explanation</i>
C-	Crew or operator maintenance done within organizational or aviation maintenance.
O-	Organizational or aviation unit category can remove, replace, and use the item.
F-	Direct support or aviation intermediate category can remove, replace, and use the item.
H-	General support category can remove, replace, and use the item.
L-	Specialized repair activity can remove, replace, and use the item.
D-	Depot category can remove, replace, and use the item.

(b) The maintenance code entered in the fourth position tells whether or not the item is to be repaired and identifies the lowest maintenance category with the capability to do complete repair (i.e., perform all authorized repair functions). This position will contain one of the following maintenance codes.

NOTE

Some limited repair may be done on the item at a lower category of maintenance, if authorized by the Maintenance Allocation Chart (MAC) and SMR codes.

<i>Code</i>	<i>Application/Explanation</i>
O-	Organizational or aviation unit is the lowest category that can do complete repair of the item.
F-	Direct support or aviation intermediate is the lowest category that can do complete repair of the item.
H-	General support is the lowest category that can do complete repair of the item.
L-	Specialized repair activity (designate the specialized repair activity) is the lowest category that can do complete repair of the item.
D-	Depot is the lowest category that can do complete repair of the item.
Z-	Nonreparable. No repair is authorized.
B-	No repair is authorized. (No parts or special tools are authorized for the maintenance of a "B" coded item). However, the item may be reconditioned by adjusting, lubricating, etc., at the user category.

(3) *Recoverability code*. Recoverability codes are assigned to items to indicate the disposition action on unserviceable items. The recoverability code is entered in the fifth position of the SMR Code as follows:

<i>Recoverability Codes</i>	<i>Application/Explanation</i>
Z-	Nonreparable Item. When unserviceable, condemn and dispose of the item at the category of maintenance shown in the third position of SMR Code.
O-	Reparable item. When uneconomically repairable, condemn and dispose of the item at organizational or aviation unit category.
F-	Reparable item. When uneconomically repairable, condemn and dispose of the item at direct support or aviation intermediate category.
H-	Reparable item. When uneconomically repairable, condemn and dispose of the item at general support category.
D-	Reparable item. When beyond lower category repair capability, return to depot. Condemnation and disposal of item not authorized below depot category.
L-	Reparable item. Condemnation and disposal not authorized below specialized repair activity (SRA).
A-	Item requires special handling or condemnation procedures because of specific reasons (e.g., precious metal content, high dollar value, critical material, or hazardous material). Refer to appropriate manuals/directives for specific instructions.

c. *FSCM (Column (3))*. The Federal Supply Code for Manufacturer (FSCM) is a 5-digit numeric code which is used to identify the manufacturer, distributor, or Government agency, etc., that supplies the item.

d. *Part Number (Column (4))*. Indicates the primary number used by the manufacturer (individual, company, firm, corporation, or Government activity), which controls the design and characteristics of the item by means of its engineering drawings, specifications, standards, and inspection requirements to identify an item or range of items.

NOTE

When you use a NSN to requisition an item, the item you receive may have a different part number from the part ordered.

e. *Description and Usable on Code (UOC) (Column (5))*. This column includes the following information.

(1) The Federal item name and, when required, a minimum description to identify the item.

(2) The statement "END OF FIGURE" appears just below the last item description in Column (5) for a given figure in both section II and section III.

f. *Qty (Column (6))*. Indicates the quantity of the item used in the breakout shown on the illustration figure,

which is prepared for a functional group, subfunctional group, or an assembly. A “V” appearing in this column in lieu of a quantity indicates that the quantity is variable and the quantity may vary from application to application.

4. Explanation of Columns (Section IV)

a. National Stock Number (NSN) Index.

(1) *Stock number column.* This column lists the NSN by National item identification number (NIIN) sequence. The NIIN consists of the last nine digits of the NSN. When using this column to locate an item, ignore the first four digits of the NSN. When requisitioning items use the complete NSN (13 digits).

(2) *Fig. column.* This column lists the number of the figure where the item is identified/located. The illustrations are in numerical sequence in sections II and III.

(3) *Item column.* The item number identifies the item associated with the figure listed in the adjacent Fig. column. This item is also identified by the NSN listed on the same line.

b. Part Number Index. Part numbers in this index are listed by part number in ascending alphameric sequence.

(1) *FSCM column.* This column lists the Federal supply code for manufacturer (FSCM).

(2) *Part number column.* This column indicates the part number assigned to the item.

(3) *Stock number column.* This column lists the National stock number for the associated part number and manufacturer identified in the part number and FSCM columns to the left.

(4) *Fig. column.* This column lists the number of the figure where the item is identified/located in sections II and III.

(5) *Item column.* The item number is that number assigned to the item as it appears in the figure referenced in the adjacent figure number column.

5. Special Information

a. *Associated Publications.* The publication listed below pertains to the AN/URM-206 and its components: TM 11-6625-2948-14&P, Signal Generator AN/URM-206.

b. *National Stock Numbers.* National stock numbers (NSN'S) that are missing from P source coded items have been applied for and will be added to this TM by future change/revision when they are entered in the Army Master Data File (AMDF). Until the NSN'S are established and published, submit exception requisition to: Commander, US Army Communications-Electronics Command and Fort Monmouth, ATTN: AMSEL-MM, Fort Monmouth, NJ 07703-5006 for the part required to support your equipment.

6. How to Locate Repair Parts

a. When National stock number or part number is not known.

(1) *First.* Using the table of contents, determine the assembly group or subassembly group to which the item belongs. This is necessary since figures are prepared for assembly groups and subassembly groups, and listings are divided into the same groups.

(2) *Second.* Find the figure covering the assembly group or subassembly group to which the item belongs.

(3) *Third.* Identify the item on the figure and note the item number.

(4) *Fourth.* Refer to the Repair Parts List for the figure to find the part number for the item number noted on the figure.

(5) *Fifth.* Refer to the Part Number Index to find the NSN, if assigned.

b. When National stock number or part number is known.

(1) *First.* Using the index of National stock numbers and part numbers, find the pertinent National stock number or part number. The NSN index is in National item identification number (NIIN) sequence (para 4a(1)). The part numbers in the part number index are listed in ascending alphameric sequence (para 4b). Both indexes cross-reference you to the illustration figure and item number of the item you are looking for.

(2) *Second.* After finding the figure and item number, verify that the item is the one you're looking for, then locate the item number in the repair parts list for the figure.

7. Abbreviations

Not applicable.

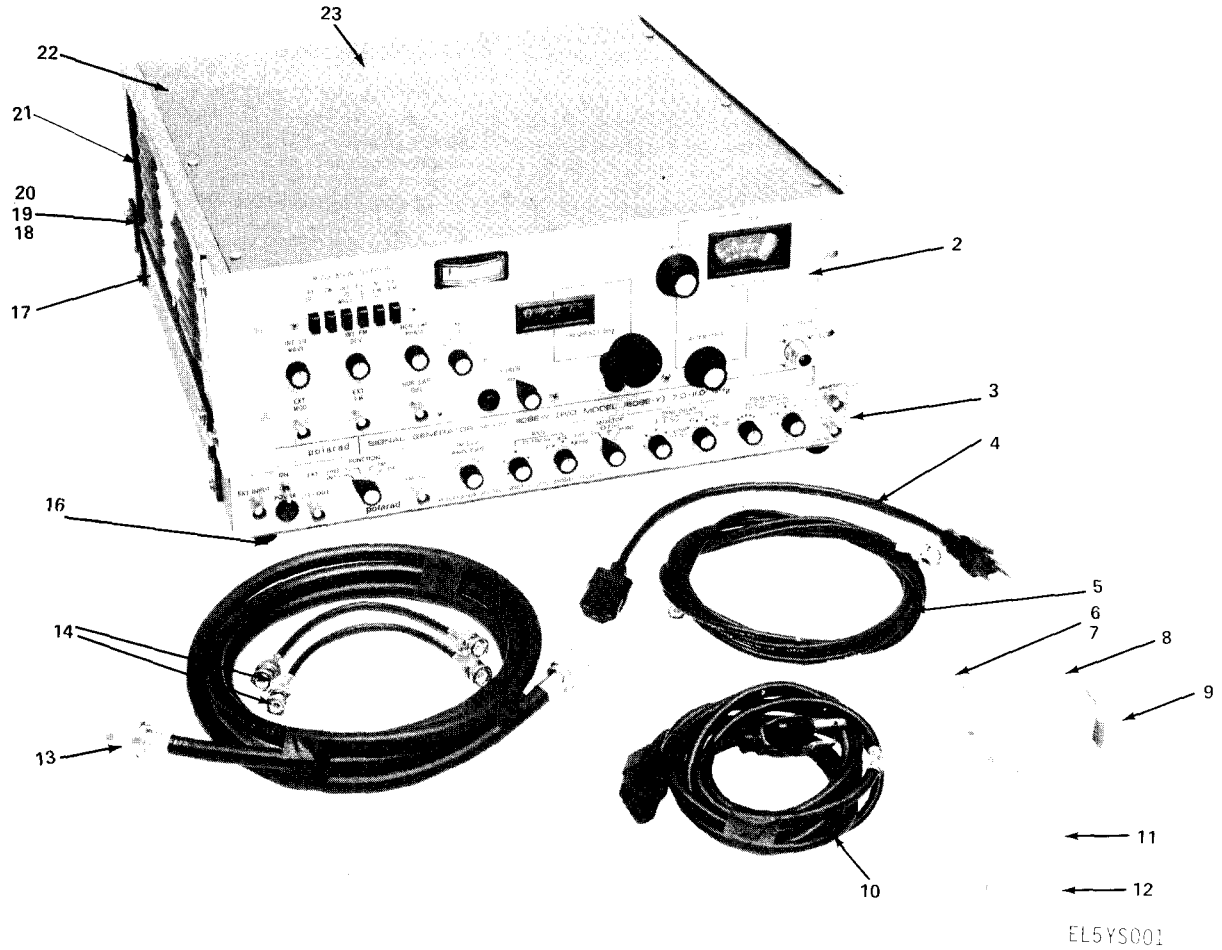

PREFIX ALL REFERENCE DESIGNATIONS WITH 1

NOTE: ITEM 1 NOT USED.

Figure 1. Signal Generator AN/URM-206

SECTION II

TM11-6625-2948-24P

(1) ITEM NO	(2) SMR CODE	(3) FSCM	(4) PART NUMBER	(5) DESCRIPTION AND USABLE ON CODE (UOC)	(6) QTY
GROUP. 00 SIGNAL GENERATOR AN/URM-206					
FIG. 1					
2	PAHDL	80058	SG-1145/URM	GENERATOR,SIGNAL	1
3	PAHDH	80058	MD-1075/URM	MODULATOR,SIGNAL GE	1
4	PAOZZ	82199	B160826	CABLE ASSEMBLY	1
5	PAOZZ	82199	BP12553	CABLE ASSEMBLY,RADI	1
6	PAOZZ	00779	1-480704-0	CONNECTOR,PLUG,ELEC	1
7	PAOZZ	00779	350689-1	CONTACT,ELECTRICAL	1
8	XBOZZ	82199	A165931-1	BRACKET,RACK MOUNT	1
9	XBOZZ	82199	A165931-2	BRACKET,RACK MOUNT	1
10	PAOZZ	82199	B160833	CABLE ASSEMBLY	1
11	PAOZZ	81349	F02A250V1/4A	FUSE,CARTRIDGE USED IN MD-1075/URM FOR 115 VAC OPERATION	1
12	PAOZZ	81349	F02A250V1/8A	FUSE,CARTRIDGE USED IN MD-1075/URM FOR 230 VAC OPERATION	1
13	PAOZZ	82199	BP12551	CABLE ASSEMBLY,RADI	1
14	PAOZZ	82199	C147363	CABLE ASSEMBLY,VIDE	2
15	PADZZ	96906	MS51957-19	SCREW,MACHINE	4
16	PADZZ	83330	2193	BUMPER,RUBBER	4
17	XBOZZ	82199	A153211-2	PLATE,SUPPORT	1
18	PAOZZ	96906	MS35338-138	WASHER,LOCK	1
19	PAOZZ	06424	0770-9	WASHER,FLAT	1
20	PAOZZ	96906	MS51958-67	SCREW,MACHINE	1
21	XBDZZ	82199	A148558	PLATE,SIDE	1
22	PADZZ	96906	MS51959-28	SCREW,MACHINE	6
23	XBDZZ	82199	B148560	COVER, TOP	1

END OF FIGURE

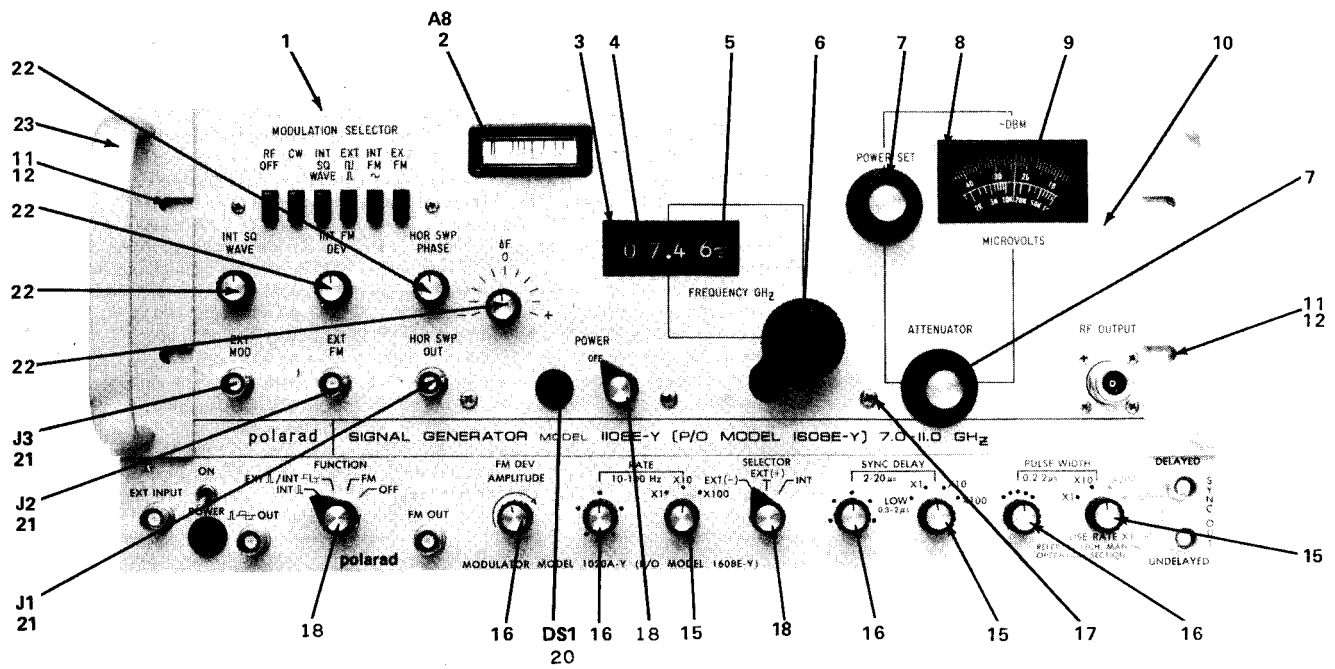

EL5YS002

NOTE: ITEMS 13, 14, 19 NOT USED.

Figure 2. Signal Generator AN/URM-206, Front View

SECTION II

TM11-6625-2948-24P

(1) ITEM NO	(2) SMR CODE	(3) FSCM	(4) PART NUMBER	(5) DESCRIPTION AND USABLE ON CODE (UOC)	(6) QTY
FIG. 2					
1	PADZZ	82199	D161523	PANEL, BLANK	1
2	PADZZ	82199	B161311	METER	1
3	XBDZZ	82199	B159494	BEZEL	1
4	XBDZZ	82199	A148998	WINDOW, OBSERVATION	1
5	PADZZ	18911	4D8861RCL	COUNTER, ROTATING	1
6	PAOZZ	82199	B713439	KNOB	1
7	PAOZZ	23480	9EC2B2	KNOB	2
8	XBDZZ	82199	B159495	BEZEL	1
9	PADZZ	82199	A148079	WINDOW	1
10	XBDZZ	82199	C161496	PANEL	1
11	PADZZ	96906	MS51959-64	SCREW, MACHINE	4
12	PADZZ	81349	MS21044C3	NUT, SELF-LOCKING, HE	4
15	PAOZZ	23480	5CC1B2	KNOB	3
16	PAOZZ	23480	5CC2B2	KNOB	4
17	PADZZ	96906	MS51957-29	SCREW, MACHINE	7
18	PAOZZ	23480	5PC2B2	KNOB	2
20	PADZZ	95263	32-1111T	LIGHT, INDICATOR	1
21	PADZZ	82199	B161509	CONNECTOR, RECEPTACL	3
22	PAOZZ	23488	5CC2B2	KNOB	4
23	XBDZZ	82199	B148270	HANDLE	2

END OF FIGURE

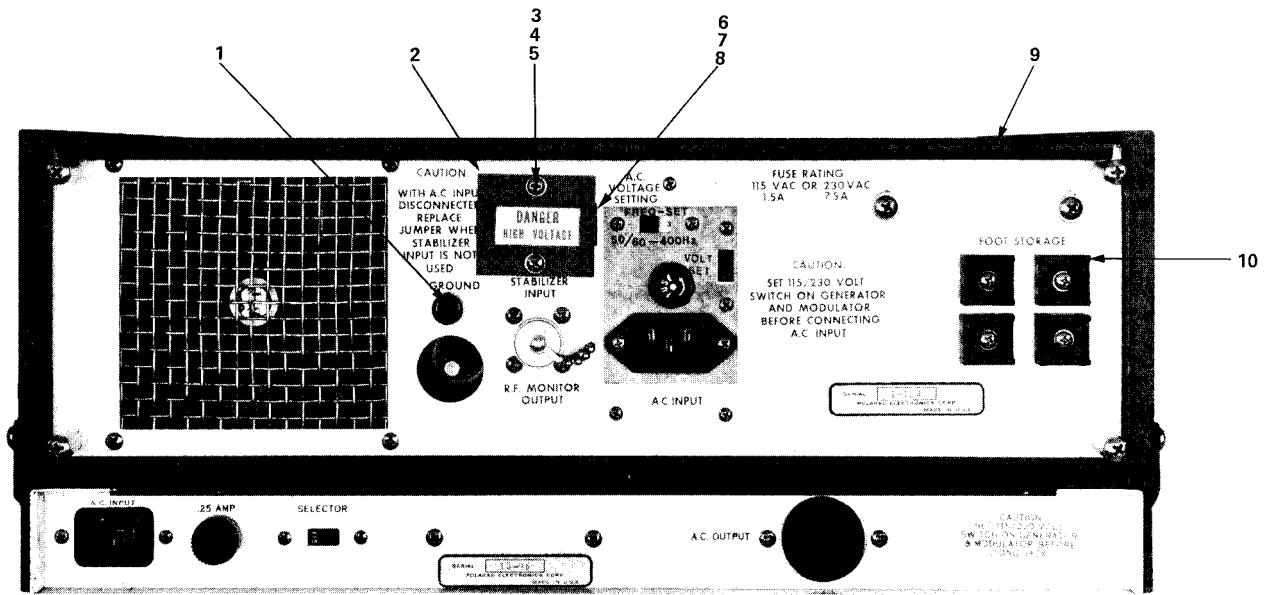

EL5YS003

Figure 2A. Signal Generator AN/URM-206, Rear View

SECTION II

TM11-6625-2948-24P

(1) ITEM NO	(2) SMR CODE	(3) FSCM	(4) PART NUMBER	(5) DESCRIPTION AND USABLE ON CODE (UOC)	(6) QTY
				FIG. 2A	
1	XBDZZ	83330	379BLACK	POST,BINDING,ELECTR	1
2	XBDZZ	82199	A149163	COVER	1
3	XBDZZ	82199	A710396	SHORTING LINK	1
4	PADZZ	82199	531730	SCREW,MACHINE	2
5	PADZZ	96906	MS35330-70	WASHER,LOCK	4
6	XBDZZ	83330	872	TERMINAL BOARD	1
7	XBDZZ	82199	B161497	CABLE ASSEMBLY,SPEC	1
8	XBDZZ	82199	A710396	TERMINAL LINK	1
9	XBDZZ	82199	A149163	COVER	1
10	XBDZZ	82199	A148559	FOOT	4

END OF FIGURE

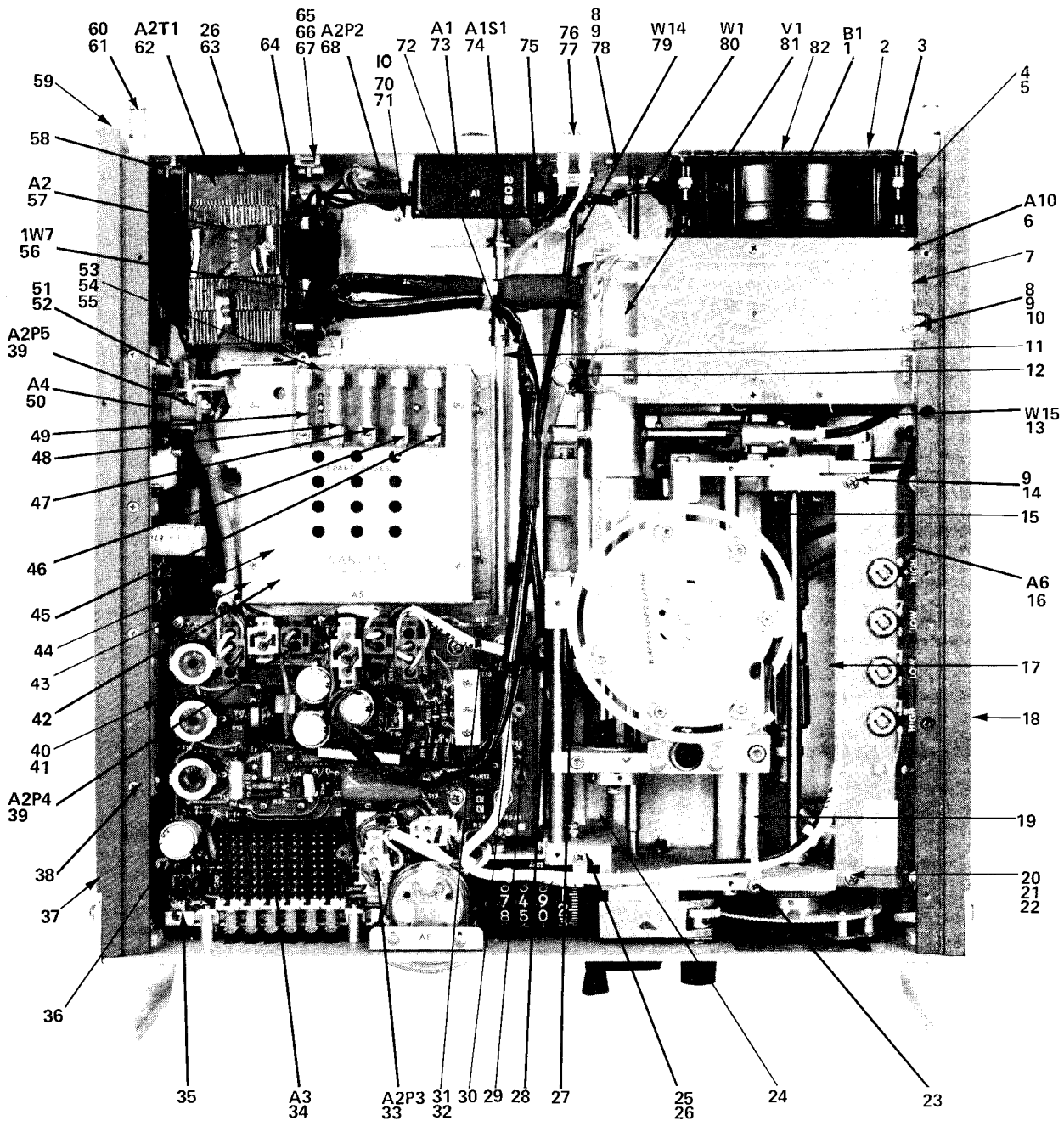

PREFIX ALL REFERENCE DESIGNATIONS WITH 1
ITEM 69 NOT USED

EL5YS004

Figure 3. Signal Generator SG-1145/URM, Top View

(1) ITEM NO	(2) SMR CODE	(3) FSCM	(4) PART NUMBER	(5) DESCRIPTION AND USABLE ON CODE (UOC)	(6) QTY
				GROUP. 01 SIGNAL GENERATOR SG-1145/URM TOP VIEW	
				FIG. 3	
1	PADZZ	82199	B702227	FAN ASSEMBLY, AXIAL PAIR NUMBER B702227 PERTAINS TO SERIAL NUMBERS FROM 5-201 TO 5-511B	1
2	XBDZZ	82199	A148690	SCREEN, FAN	1
3	PADZZ	96906	MS35338-138	WASHER, LOCK	4
4	PADZZ	96906	MS15795-807	WASHER, FLAT	4
5	PADZZ	96906	MS35649-284	NUT, PLAIN, HEXAGON	4
6	PAHZZ	82199	C167141	CONVERTER BOARD ASS	1
7	XBDZZ	82199	B161529	COVER, CONV BD	3
8	PADZZ	96906	MS51957-30	SCREW, MACHINE	4
9	PADZZ	80063	SM-B-416109-1	WASHER, FLAT	12
10	PADZZ	96906	MS35338-136	WASHER, LOCK	11
11	XBDZZ	82199	B161460	SWITCH ROD	1
12	PADZZ	96906	MS35842-15	CLAMP, HOSE	1
13	PADZZ	82199	C160850	LEAD, TEST	1
14	PADZZ	96906	MS51957-14	SCREW, MACHINE	3
15	PAHDD	82199	C161530	TUNING HEAD ASSEMBL	1
16	PADZZ	82199	C167156	TRACKING BOARD ASSE	1
17	XBDZZ	82199	C161451	COVER, BOTTOM	1
18	XBDZZ	82199	D161424-1	PANEL, SIDE	1
19	PADDD	82199	C161530-1	TUNING HEAD ASSEMBL	1
20	PADZZ	82199	503603	WASHER, FLAT	7
21	PADZZ	82199	515903	WASHER, LOCK	9
22	PADZZ	82199	531727	SCREW, MACHINE	4
23	PADZZ	96906	MS51959-28	SCREW, MACHINE	1
24	XBDZZ	82199	B161447	SUPPORT, CHASSIS	1
25	PADZZ	96906	MS51957-47	SCREW, MACHINE	1
26	PADZZ	96906	MS35338-137	WASHER, LOCK	4
27	PADZZ	96906	MS51957-19	SCREW, MACHINE	4
28	PADZZ	96906	MS51959-3	SCREW, MACHINE	1
29	XBDZZ	82199	B161528	SPACER	3
30	PADZZ	78553	C61254AA015	CLAMP, CABLE, ELECTRI	1
31	PADZZ	96906	MS51959-28	SCREW, MACHINE	3
32	PADZZ	96906	MS77068-2	TERMINAL, LUG	1
33	PADZZ	00779	1-480702-0	CONNECTOR, PLUG, ELEC	1
34	PAHDD	82199	D161469-1	PUSHBUTTON BOARD A	1
35	PADZZ	96906	MS51959-17	SCREW, MACHINE	11
36	PADZZ	82199	A161459	SPACER, SUPPORT	2
37	PADZZ	82199	B148612	COVER, ACCESS	1
38	PADZZ	96906	MS51957-25	SCREW, MACHINE	12
39	PADZZ	00779	1-480698-0	CONNECTOR BODY, PLUG	2
40	XBDZZ	82199	B161445	BRACKET	2
41	XBDZZ	82199	A161456	SPACER	1
42	PAHDD	82199	D161309	BOX ASSEMBLY	1
43	PADZZ	01614	22	COVER	1
44	PADZZ	82199	C161493	COVER, ACCESS	1

SECTION II

TM11-6625-2948-24P

(1) ITEM NO	(2) SMR CODE	(3) FSCM	(4) PART NUMBER	(5) DESCRIPTION AND USABLE ON CODE (UOC)	(6) QTY
45	PADZZ	81349	F02B250V1-1/2A	FUSE,CARTRIDGE SPARE FUSE 1.5 AMP	1
46	PAOZZ	81349	F02A250V3-4AS	FUSE,CARTRIDGE SPARE FUSE 3/4 AMP	1
47	PAOZZ	81349	F02A250V1/4A	FUSE,CARRIDGE SPARE FUSSE 2-1/2 AMP	1
48	PAOZZ	75915	31202.5	FUSE,CARTRIDGE SPARE FUSE 1/4 AMP	1
49	PAOZZ	75915	312.031	FUSE,CARTRIDGE SPARE FUSE 1/32 AMP	1
50	PAHDD	82199	C161321	HIGH VOLTAGE CONTR	1
51	PADZZ	96906	MS51957-15	SCREW,MACHINE	21
52	PADZZ	96906	MS15795-803	WASHER,FLAT	13
53	PADZZ	91833	A161906	FUSE BLOCK	1
54	PADZZ	96906	MS51957-19	SCREW,MACHINE	2
55	PADZZ	96906	MS35338-135	WASHER,LOCK	2
56	PADZZ	82199	B161506	COVER ASSEMBLY	1
57	PADZZ	82199	C161454	POWER TRANSFORMER A	1
57	PADZZ	82199	C161454(E)	TRANSFORMER,POWER PART NUMBER C161454(E) PERTAYN TO SERIAL NUMBERS FROM 5-201B TO 5-511B	1
58	PADZZ	96906	MS51959-45	SCREW,MACHINE	4
59	XBDZZ	82199	D161424-1	PANEL,SIDE	1
60	PADZZ	96906	MS51958-68	SCREW,MACHINE	4
61	PADZZ	96906	MS35338-138	WASHER,LOCK	4
62	PADZZ	82877	C161312(J)	TRANSFORMER,POWER PART NUMBER C161312(F) PERTAINS TO SERIAL NUMBERS FROM 5-201B TO 5-501B	1
63	PADZZ	96906	MS51957-45	SCREW,MACHINE	2
64	PADZZ	96906	MS35333-72	WASHER,LOCK	2
65	PADZZ	96906	MS51959-46	SCREW,MACHINE	1
66	PADZZ	96906	MS35338-135	WASHER,LOCK	13
67	PADZZ	78553	C8103-832	NUT,SHEET SPRING	4
68	PADZZ	81312	M4PLSH10C	CONNECTOR,PLUG,ELEC	1
70	PADZZ	96906	MS51957-30	SCREW,MACHINE	5
71	PADZZ	96906	MS35649-244	NUT,PLAIN,HEXAGON	3
72	XBDZZ	83330	120	COUPLING,SHAFT,RIGI	1
73	PADZZ	82199	C161521	BOX ASSEMBLY	1
74	PADZZ	71590	20BE	SWITCH,ROTARY	1
75	PADZZ	96906	MS77068-1	TERMINAL,LUG	1
76	PADZZ	00779	350689-1	CONTACT,ELECTRICAL	2
77	PADZZ	00779	350771-1	CONNECTOR BODY,RECE	1
78	PADZZ	96906	MS51957-26	SCREW,MACHINE	2
79	PADZZ	82199	A149252	CABLE ASSEMBLY,RADI	1
80	PADZZ	82199	B161527	CABLE ASSEMBLY	1
81	PADZZ	82199	A160034	ELECTRON TUBE	1
82	XBDZZ	82199	E161407	CHASSIS	1

END OF FIGURE

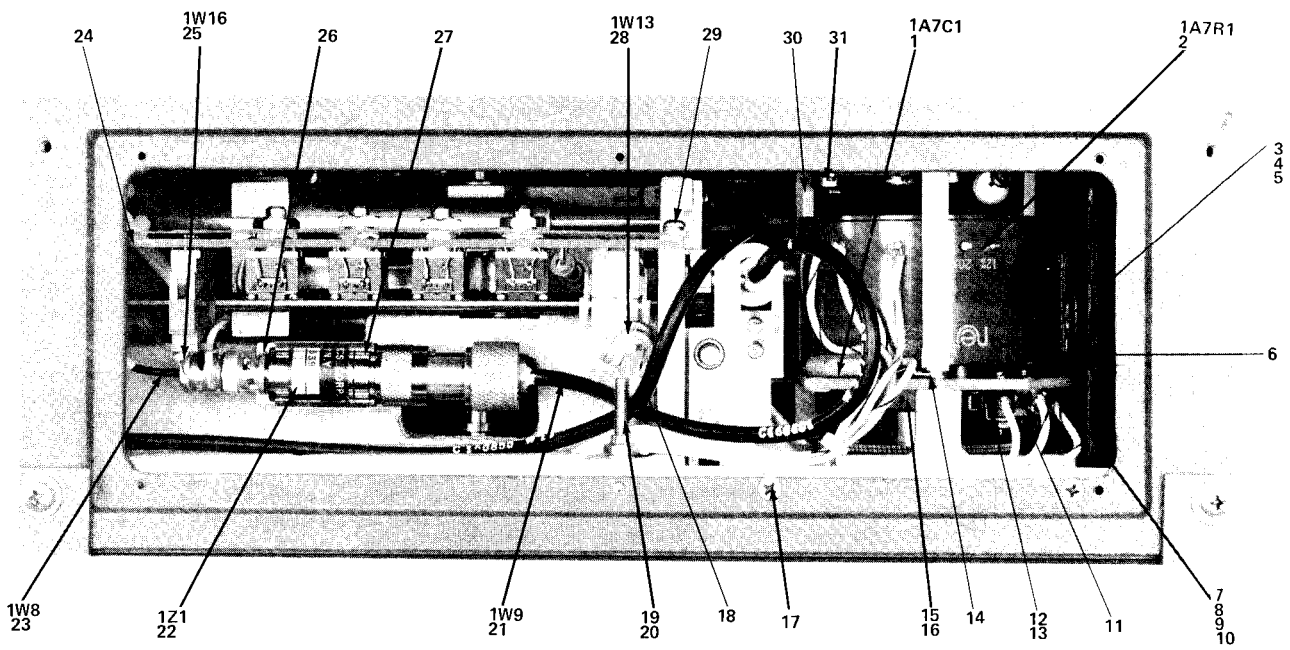

EL5YS005

Figure 4. Signal Generator SG-1145/URM, Side View

(1) ITEM NO	(2) SMR CODE	(3) FSCM	(4) PART NUMBER	(5) DESCRIPTION AND USABLE ON CODE (UOC)	(6) QTY
FIG. 4					
1	PADZZ	80183	60GA-D47	CAPACITOR, FIXED, CER	1
2	PADZZ	82199	005033	RESISTOR, VARIABLE, W	1
3	PADZZ	82199	512428	SCREW, MACHINE	2
4	PADZZ	82199	520803	WASHER, LOCK	2
5	PADZZ	82199	502823	NUT, PLAIN, HEXAGON	2
6	PADZZ	82199	C160023	SWITCH ASSEMBLY	1
7	XBDZZ	82199	B148809	BOARD, MOUNTING	1
8	PADZZ	82199	512447	SCREW, MACHINE	3
9	PADZZ	82199	503603	WASHER, FLAT	3
10	PADZZ	82199	520804	WASHER, LOCK	3
11	PADZZ	96906	MS25253-1	SWITCH, SENSITIVE	1
12	PADZZ	91929	JV5-42	ADAPTER, SWITCH	1
13	XBDZZ	82199	A159411	SPACER	3
14	XBDZZ	70892	T120-11	TERMINAL, STUD	1
15	PADZZ	82199	A148807	CAM, SWITCH	1
16	PADZZ	82199	513223	SETSCREW	2
17	PADZZ	96906	MS51959-29	SCREW, MACHINE	2
				UOC:DTW	
18	PADZZ	95987	3/16-6	CLAMP, LOOP	3
19	PADZZ	96906	MS51957-51	SCREW, MACHINE	1
20	PADZZ	96906	MS21044C04	NUT, SELF-LOCKING, HE	4
21	PADZZ	82199	C160851	CABLE, ASSEMBLY	1
22	PADZZ	82199	A160359	DETECTOR	1
23	PADZZ	82199	B161503	CABLE ASSEMBLY	1
24	XBDZZ	82199	B161514	TRACKING BD COVER	1
25	PADZZ	82199	B161505	CABLE ASSEMBLY	1
26	XBDZZ	82199	A161417	BRACKET, DETECTOR	1
27	XBDZZ	82199	A155116	CLIP, DETECTOR	1
28	PADZZ	82199	B161526	CABLE, ASSEMBLY	1
29	XBDZZ	82199	A161479	SPACER	4
30	XBDZZ	06540	9326B194-4	SPACER	4
31	PADZZ	96906	MS51957-16	SCREW, MACHINE	3

END OF FIGURE

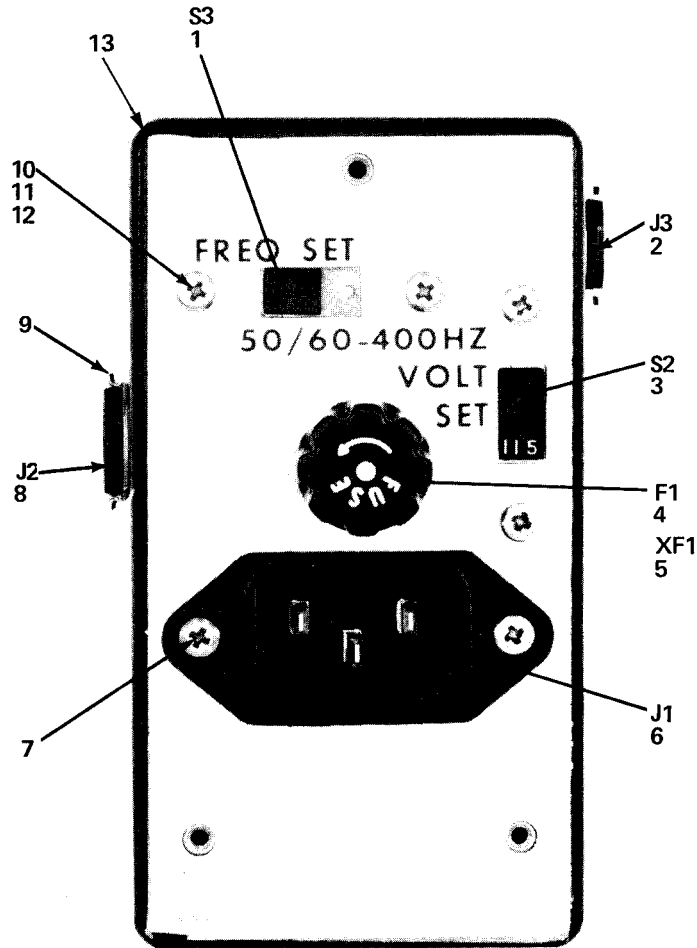

EL5YS006

PREFIX ALL REFERENCE DESIGNATIONS WITH 1A1

Figure 5. AC Box Assembly

SECTION II

TM11-6625-2948-24P

(1) ITEM NO	(2) SMR CODE	(3) FSCM	(4) PART NUMBER	(5) DESCRIPTION AND USABLE ON CODE (UOC)	(6) QTY
FIG. 5					
1	PADZZ	82199	B161546	SWITCH, SLIDE	1
2	PADZZ	95238	C7-20SVRNGD	CONNECTOR, PLUG, ELEC	1
3	PADZZ	82389	46206LFR	SWITCH, SLIDE	1
4	PADZZ	81349	F02B250V1-1/2A	FUSE, CARTRIDGE	1
5	PADZZ	71400	342004	FUSEHOLDER, EXTRACTO	1
6	PADZZ	16428	17252	CONNECTOR, RECEPTACL	1
7	PADZZ	96906	MS51957-16	SCREW, MACHINE	2
8	PADZZ	81312	M4S-LRN	CONNECTOR, RECEPTACL	1
9	PADZZ	82199	A161455	INSULATOR	1
10	PADZZ	96906	MS51957-19	SCREW, MACHINE	4
11	PADZZ	96906	MS35338-135	WASHER, LOCK	6
12	PADZZ	96906	MS35650-244	NUT, PLAIN, HEXAGON	6
13	PADZZ	82199	C161525	TERMINAL BOX	1

END OF FIGURE

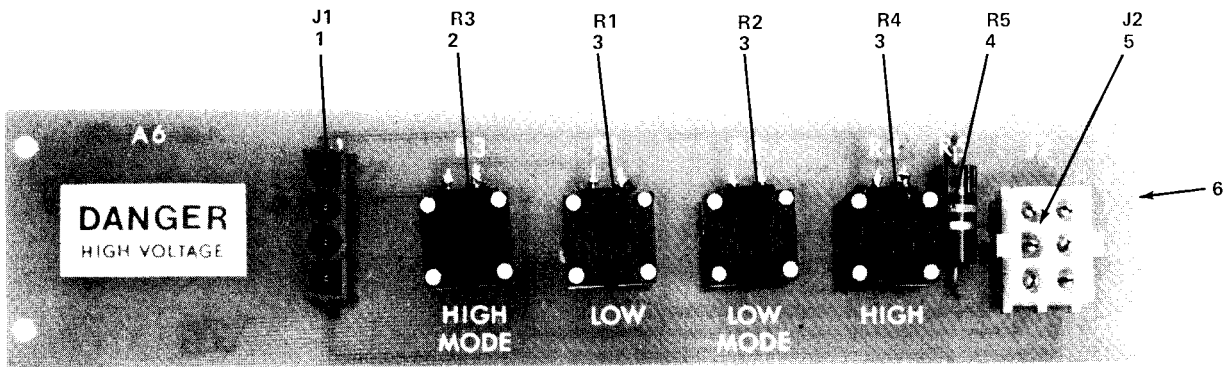

EL5YS007

PREFIX ALL REFERENCE DESIGNATIONS WITH 1A6

Figure 5A. Tracking Board Assembly

SECTION II

TM11-6625-2948-24P

(1) ITEM NO	(2) SMR CODE	(3) FSCM	(4) PART NUMBER	(5) DESCRIPTION AND USABLE ON CODE (UOC)	(6) QTY
				FIG. 5A	
1	PADZZ	00779	350792-1/RED/	CONNECTOR,RECEPTACL	1
2	PADZZ	01121	70N1M0325254W	RES,VARIABLE	1
3	PADZZ	01121	70N1M032S104W	RESISTOR,VARIABLE,N	3
4	PADZZ	81349	RCR20G183JS	RESISTOR,FIXED,COMP	1
5	PADZZ	00779	350431-1	CONNECTOR,RECEPTACL	1
6	PADZZ	82199	A167156-1	PC BOARD	1

END OF FIGURE

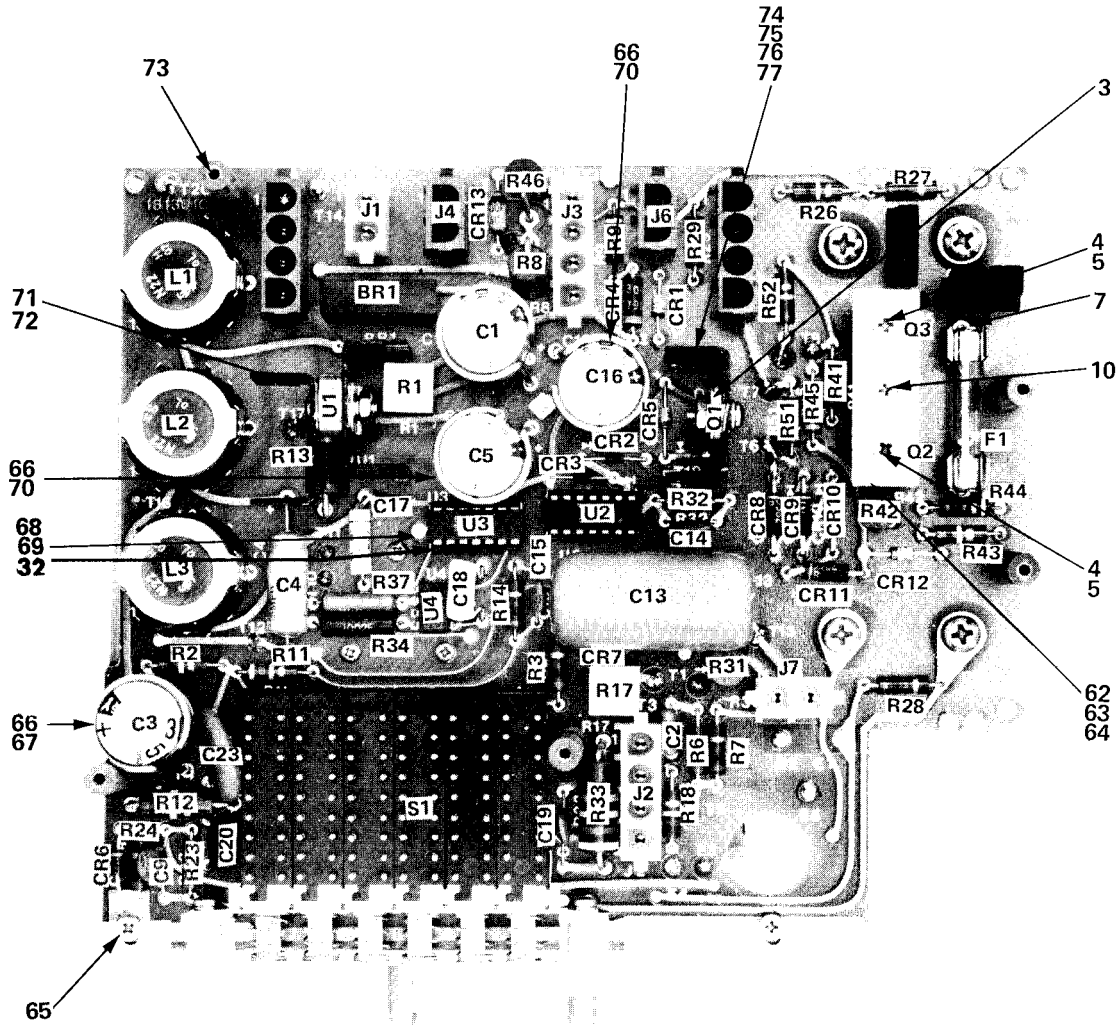

EL5YS008

PREFIX ALL REFERENCE DESIGNATIONS WITH 1A3

LEGEND

TOP VIEW

REF DES	ITEM NO.	REF DES	ITEM NO.	REF DES	ITEM NO.	REF DES	ITEM NO.
BR1	52	CR5	35	Q2	6	R29	59
C1	50	CR6	35	Q3	6	R31	22
C2	24	CR7	61	R1	51	R32	20
C3	38	CR8	17	R2	14	R33	27
C4	43	CR9	17	R3	18	R34	40
C5	50	CR10	17	R6	14	R37	41
C9	34	CR11	17	R7	18	R41	9
C13	23	CR12	16	R8	13	R42	15
C14	21	CR13	54	R9	47	R43	14
C15	29	F1	8	R11	39	R44	13
C16	50	J1	19	R12	36	R45	11
C17	44	J2	56	R13	47	R46	55
C18	24	J3	56	R14	18	R51	12
C19	28	J4	53	R17	26	R52	1
C20	33	J5	53	R18	25	S1	30
C23	37	J7	19	R23	20	U1	49
CR1	58	L1	42	R24	18	U2	46
CR2	48	L2	42	R26	14	U3	45
CR3	48	L3	42	R27	60	U4	31
CR4	57	Q1	2	R28	18		

Figure 6. Pushbutton Board Assembly, D161469

(1) ITEM NO	(2) SMR CODE	(3) FSCM	(4) PART NUMBER	(5) DESCRIPTION AND USABLE ON CODE (UOC)	(6) QTY
GROUP. 0101 PUSHBUTTON BOARD					
ASSEMBLY D161469					
FIG. 6					
1	PADZZ	81349	RCR20G153JS	RESISTOR, FIXED, COMP	1
2	PADZZ	03508	D40E7	TRANSISTOR	1
3	PADZZ	91833	1253	SOCKET	2
4	PADZZ	91506	8058-1G23	SOCKET, PLUG-IN ELEC	2
5	PADZZ	96906	MS51957-19	SCREW, MACHINE	2
6	PADZZ	81349	JAN2N5416	TRANSISTOR	2
7	PADZZ	75915	102074	CLIP, ELECTRICAL	2
8	PADZZ	75915	312.031	FUSE, CARTRIDGE	1
9	PADZZ	81349	RCR20G621JS	RESISTOR, FIXED, COMP	1
10	PADZZ	96906	MS51957-15	SCREW, MACHINE	2
11	PADZZ	81349	RCR20G393JS	RESISTOR, FIXED, COMP	1
12	PADZZ	81349	RCR20G392JS	RESISTOR, FIXED, COMP	1
13	PADZZ	81349	RCR42G102JS	RESISTOR, FIXED, COMP	2
14	PADZZ	81349	RCR20G104JS	RESISTOR, FIXED, COMP	4
15	PADZZ	80294	3339H-L-204	RES, VARIABLE	1
16	PADZZ	80131	1N4762A	SEMICONDUCTOR DEVIC	1
17	PADZZ	04713	1N5382B	SEMICONDUCTOR DEVIC	4
18	PADZZ	81349	RCR20G105JS	RESISTOR, FIXED, COMP	5
19	PADZZ	00779	350428-1	CONNECTOR, PLUG, ELEC	2
20	PADZZ	81349	RCR20G103JS	RESISTOR, FIXED, COMP	2
21	PADZZ	71590	DD102	CAPACITOR, FIXED, CER	1
22	PADZZ	32997	3339H-1-502	RESISTOR, VARIABLE, N CONTROL	1
23	PADZZ	56289	16PS-S50	CAPACITOR, FIXED, CER	1
24	PADZZ	73445	PMG1002A	CAP, FXD, PLASTIC	2
25	PADZZ	81349	RCR20G274JS	RESISTOR, FIXED, COMP	1
26	PADZZ	73138	72P254	RESISTOR, VARIABLE, N CONTROL	1
27	PADZZ	81349	RCR42G473JS	RESISTOR, FIXED, COMP	1
28	PADZZ	71590	DD-271	CAPACITOR, FIXED, CER	1
29	PADZZ	81349	CK60BX470K	7CAPACITOR, FIXED, CE	1
30	PADZZ	82199	B161316	SWITCH, PUSH	1
31	PADZZ	81349	M38510/10901BPB	MICROCIRCUIT, LINEAR	1
32	PADZZ	91506	314AG39D	SOCKET, PLUG-IN ELEC	2
33	PADZZ	72982	811-000-2540-103 M	CAPACITOR, FIXED, CER	1
34	PADZZ	81349	CK60AX331K	CAPACITOR, FIXED, CER	1
35	PADZZ	80131	1N4759A	SEMICONDUCTOR DEVIC	2
36	PADZZ	81349	RCR32G104JS	RESISTOR, FIXED, COMP	1
37	PADZZ	80183	60GA-D47	CAPACITOR, FIXED, CER	1
38	PADZZ	90201	VTL330S50	CAPACITOR, FIXED, ELE	1
39	PADZZ	81349	RCR20G474JS	RESISTOR, FIXED, COMP	1
40	PADZZ	81349	RNC65H1002FS	RESISTOR, FIXED, FILM	1
41	PADZZ	81349	RNC65H2612FS	RESISTOR, FIXED, FILM	1
42	PADZZ	82199	A161462	REACTOR	3
43	PADZZ	56289	30D256G050CC2	CAPACITOR, FIXED, ELE	1
44	PADZZ	84411	663UW	CAPACITOR, FIXED, PLA	1

SECTION II

TM11-6625-2948-24P

(1) ITEM NO	(2) SMR CODE	(3) FSCM	(4) PART NUMBER	(5) DESCRIPTION AND USABLE ON CODE (UOC)	(6) QTY
45	PADZZ	81349	M38510/05101BCB	MICROCIRCUIT,DIGITA	1
46	PADZZ	07148	80787-1	MICROCIRCUIT,DIGITA	1
47	PADZZ	81349	RCR20G102JS	RESISTOR,FIXED,COMP	2
48	PADZZ	81349	1N456	SEMICONDUCTOR DEVIC	2
49	PADZZ	34148	UA78GU1C	MICROCIRCUIT,LINEAR	1
50	PADZZ	56289	503D108G016ER	CAPACITOR,FIXED,ELE	3
51	PADZZ	73138	72PR5K	RESISTOR,VARIABLE,N CONTROL	1
52	PADZZ	04713	MDA970A1	RECTIFIER,SEMICONDU	1
53	PADZZ	00779	350786-1	CONNECTOR,PLUG,ELEC	2
54	PADZZ	14099	SH30F	SEMICONDUCTOR DEVIC	1
55	PADZZ	81349	RC42GF104J	RESISTOR,FIXED,COMP	1
56	PADZZ	00779	350430-1	CONNECTOR,PLUG,ELEC	2
57	PADZZ	83701	EG300	SEMICONDUCTOR DEVIC	1
58	PADZZ	81349	JAN1N4467	SEMICONDUCTOR DEVIC	1
59	PADZZ	81349	RCR20G224JS	RESISTOR,FIXED,COMP	1
60	PADZZ	81349	RCR20G152JS	RESISTOR,FIXED,COMP	1
61	PADZZ	81349	JAN1N914	SEMICONDUCTOR DEVIC	1
62	XBDZZ	82199	B161486	COVER,HV	1
63	XBDZZ	82199	A161468	SPACER	2
64	XBDZZ	82199	A161461	STANDOFF	2
65	PADZZ	96906	MS51957-19	SCREW,MACHINE	4
66	PADZZ	82199	A161457-1	CAPACITOR	4
67	PADZZ	06540	8582B0832-3A	STANDOFF,CAP	2
68	PADZZ	96906	MS35338-135	WASHER,LOCK	4
69	PADZZ	96906	MS51957-43	SCREW,MACHINE	4
70	PADZZ	06540	8592B0832-3A	STANDOFF,CAPACITOR	2
71	PADZZ	13103	6030B	HEAT SINK,ELECTRICA	2
72	PADZZ	82199	A161517	SPACER	1
73	XBDZZ	06540	8166PH0440	SPACER	5
74	PADZZ	13103	1116B	HEAT SINK,ELECTRICA	2
75	XBDZZ	82199	A161463	BRACKET,HEATSINK	1
76	XBDZZ	06540	8217A440	STANDOFF,HEATSINK	1
77	XBDZZ	82199	A161474	SPACER	4

END OF FIGURE

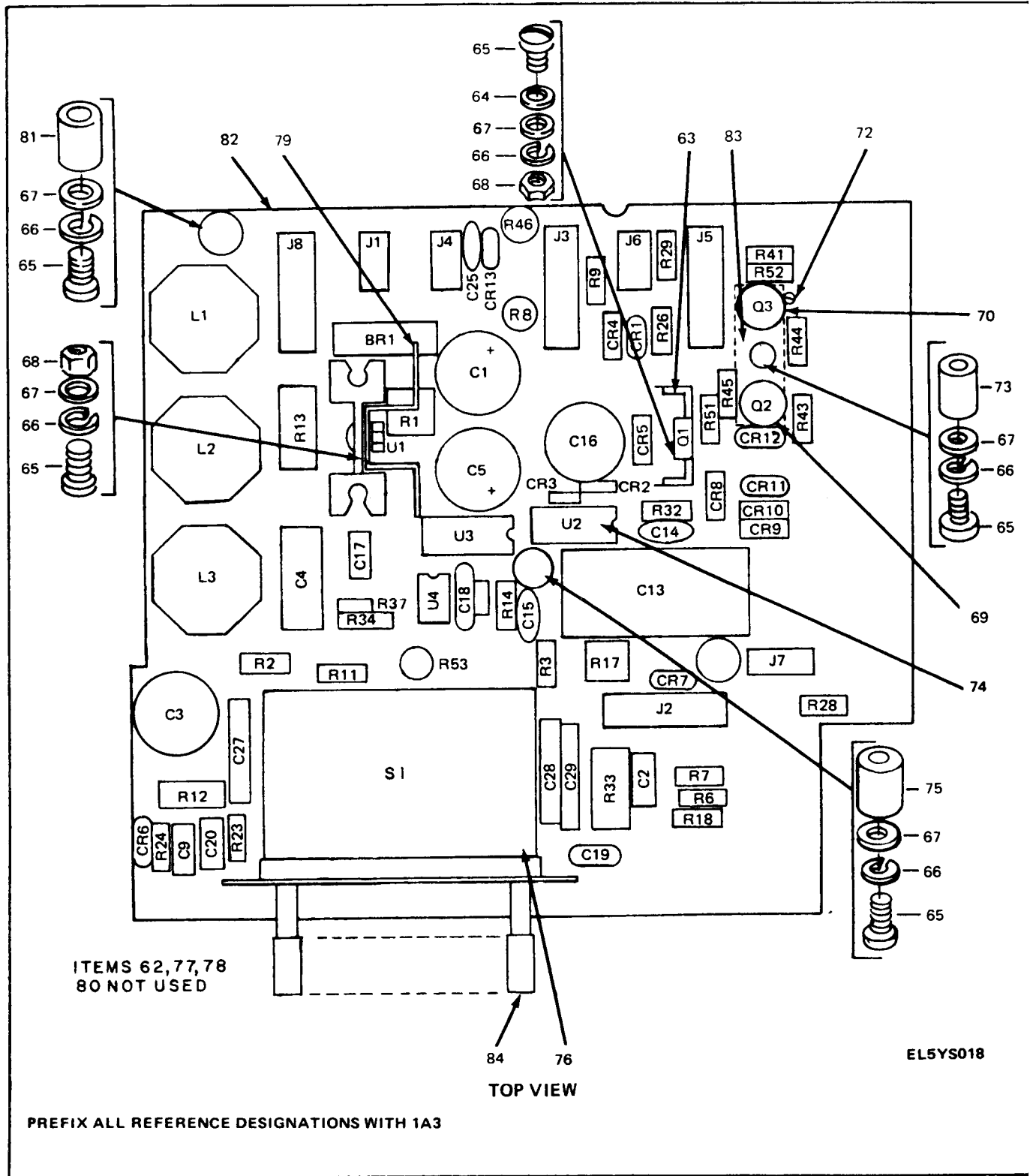

Figure 6A. Pushbutton Board Assembly, B161606-2,
(Sheet 1 of 2).

LEGEND FOR FIGURE 6A

REF DES.	ITEM NO.	REF DES.	ITEM NO.	REF DES.	ITEM NO.
BR1	1	CR8	20	R12	41
C1	2	CR9	20	R13	38
C2	3	CR10	20	R14	37
C3	4	CR11	21	R17	42
C4	5	CR12	22	R18	43
C5	2	CR13	23	R23	44
C9	6	J1	24	R24	37
C13	7	J2	25	R26	36
C14	8	J3	26	R28	37
C15	9	J4	27	R29	45
C16	2	J5	28	R31	46
C17	10	J6	29	R32	44
C18	11	J7	30	R33	47
C19	11	J8	31	R34	48
C20	12	L1	32	R37	49
C25	13	L2	32	R41	50
C27	14	L3	32	R43	36
C28	14	Q1	33	R44	51
C29	14	Q2	34	R45	52
CR1	15	Q3	34	R46	53
CR2	16	R1	35	R51	54
CR3	16	R2	36	R52	55
CR4	17	R3	37	R53	56
CR5	18	R6	36	S1	61
CR6	18	R7	37	U1	57
CR7	19	R8	38	U2	58
		R9	39	U3	59
		R11	40	U4	60

EL5YS018

Figure 6A. Pushbutton Board Assembly, B161606-2,
(Sheet 2 of 2).

SECTION II

TM11-6625-2948-24P

(1) ITEM NO	(2) SMR CODE	(3) FSCM	(4) PART NUMBER	(5) DESCRIPTION AND USABLE ON CODE (UOC)	(6) QTY
FIG. 6A					
1	PADZZ	04713	MDA970A1	RECTIFIER, SEMICONDU SERIAL NO. 5- 201B THRU 5-511B	1
2	PADZZ	56289	503D108G016ER	CAPACITOR, FIXED, ELE SERIAL NO. 5- 201B THRU 5-511B	3
3	PADZZ	73445	PMG-10002A	CAPACITOR, FIXED, MYL SERIAL NO. 5- 201B THRU 5-511B	2
4	PCDZZ	90201	VTL330S50	CAPACITOR, FIXED, ELE SERIAL NO. 5- 201B THRU 5-511B	1
5	PADZZ	56289	30D256G050CC2	CAPACITOR, FIXED, ELE SERIAL NO. 5- 201B THRU 5-511B	1
6	PADZZ	14655	DD331	CAP, FXD, CERAMIC SERIAL NO. 5-201B THRU 5-511B	800
7	PADZZ	56289	16PS-S50	CAPACITOR, FIXED, CER SERIAL NO. 5- 201-B THRU 5-511B	1
8	PADZZ	14655	DD102	CAP, FXD, CERAMIC SERIAL NO. 5-201B THRU 5-511B	1
9	PADZZ	14655	DD470	CAP, FXD, CERAMIC SERIAL NO. 5-201B THRU 5-511B	1
10	PADZZ	84411	X463UW	CAPACITOR, FIXED, MYL SERIAL NO. 5- 201B THRU 5-511B	1
11	PADZZ	73445	PMG1001-A	CAPACITOR, FIXED, FIL SERIAL NO. 5- 201B THRU 5-511B	2
12	PADZZ	72982	811-000-2540-103	CAPACITOR, FIXED, CER	1
13	PADZZ	14655	DD30-220	CAPACITOR, FIXED, CER SERIAL NO. 5- 201B THRU 5-511B	1
14	PADZZ	14655	DD16-153	CAPACITOR, FIXED, CER SERIAL NO. 5- 201B THRU 5-511B	3
15	PADZZ	81349	JAN1N4467	SEMICONDUCTOR DEVIC SERIAL NO. 5- 201B THRU 5-511B	1
16	PADZZ	81349	1N456	SEMICONDUCTOR DEVIC SERIAL NO. 5- 201B THRU 5-511B	2
17	PADZZ	83701	EG300	SEMICONDUCTOR DEVIC SERIAL NO. 5- 201B THRU 5-511B	1
18	PADZZ	80131	1N4759A	SEMICONDUCTOR DEVIC SERIAL NO. 5- 201B THRU 5-511B	2
19	PADZZ	81349	JAN1N914	SEMICONDUCTOR DEVIC SERIAL NO. 5- 201B THRU 5-511B	1
20	PADZZ	81349	1N5382B	SEMICONDUCTOR DEVIC SERIAL NO. 5- 201B THRU 5-511B	3
21	PADZZ	81349	JAN1N4476	SEMICONDUCTOR DEVIC SERIAL NO. 5- 201B THRU 5-511B	1
22	PADZZ	80131	1N4762A	SEMICONDUCTOR DEVIC SERIAL NO. 5- 201B THRU 5-511B	1
23	PADZZ	14099	SH30F	SEMICONDUCTOR DEVIC SERIAL NO. 5- 201B THRU 5-511B	1

SECTION II

TM11-6625-2948-24P

(1) ITEM NO	(2) SMR CODE	(3) FSCM	(4) PART NUMBER	(5) DESCRIPTION AND USABLE ON CODE (UOC)	(6) QTY
24	PADZZ	82199	C162191-1	CONNECTOR, RECEPTACL SERIAL NO.5-201B THRU 5-511B	1
25	PADZZ	82199	C162191-2	CONNECTOR, RECEPTACL SERIAL NO.5-201B THRU 5-511B	1
26	PADZZ	82199	C162191-12	CONNECTOR, RECEPTACL SERIAL NO.5-201B THRU 5-511B	1
27	PADZZ	82199	C162191-6	CONNECTOR, RECEPTACL SERIAL NO.5-201B THRU 5-511 B	1
28	PADZZ	82199	C162191-9	CONNECTOR, RECEPTACL SERIAL NO.5-201B THRU 5-511B	1
29	PADZZ	82199	C162191-7	CONNECTOR, RECEPTACL SERIAL NO.5-201B THRU 5-511B	1
30	PADZZ	82199	C162191-8	CONNECTOR, RECEPTACL SERIAL NO.5-201B THRU 5-511B	1
31	PADZZ	82199	C162191-4	CONNECTOR, RECEPTACL SERIAL NO.5-201B THRU 5-511B	1
32	PADZZ	82199	A161462	REACTOR SERIAL NO.5-201B THRU 5-511B	3
33	PADZZ	09214	D40D7	TRANSISTOR SERIAL NO.5-201B THRU 5-511B	1
34	PADZZ	81349	JAN2N5416	TRANSISTOR SERIAL NO.5-201B THRU 5-511B	2
35	PADZZ	73138	72P5K0HM	RESISTOR, VARIABLE SERIAL NO.5-201B THRU 5-511B	1
36	PADZZ	81349	RCR20G104JS	RESISTOR, FIXED, COMP SERIAL NO.5-201B THRU 5-511B	4
37	PADZZ	81349	RCR20G105JS	RESISTOR, FIXED, COMP SERIAL NO.5-201B THRU 5-511B	5
38	PADZZ	81349	RCR42G102JS	REISITOR, FIXED, COMP SERIAL NO.5-201B THRU 5-511B	2
39	PADZZ	44655	23J1K0	RESISTOR, FIXED, WIRE SEROAL NO.5-201B THRU 5-511B	1
40	PADZZ	81349	RCR20G474JS	RESISTOR, FIXED, COMP SERIAL NO.5-201B THRU 5-511B	1
41	PADZZ	81349	RCR32G104JS	RESISTOR, FIXED, COMP SERIAL NO.5-201B THRU 5-511B	1
42	PADZZ	73138	72P254	RESISTOR, VARIABLE, N SERIAL NO.5-201B THRU 5-511B	1
43	PADZZ	81349	RCR20G274JS	RESISTOR, FIXED, COMP SERIAL NO.5-201B THRU 5-511B	1
44	PADZZ	81349	RCR20G103JS	RESISTOR, FIXED, COMP SERIAL NO.5-201B THRU 5-511B	2
45	PADZZ	81349	RCR20G224JS	RESISTOR, FIXED, COMP SERIAL NO.5-201B THRU 5-511B	1
47	PADZZ	81349	RCR42G473JS	RESISTOR, FIXED, COMP SERIAL NO.5-201B THRU 5-511B	1
48	PADZZ	81349	RNC65H1002FS	RESISTOR, FIXED, FILM SERIAL NO.5-201B THRU 5-511B	1
49	PADZZ	81349	RNC55H2612FS	RESISTOR, FIXED, FILM SERIAL NO.5-201B THRU 5-511B	1
50	PADZZ	81349	RCR20G271JS	RESISTOR, FIXED, COMP SERIAL NO.5-201B THRU 5-511B	1

SECTION II

TM11-6625-2948-24P

(1) ITEM NO	(2) SMR CODE	(3) FSCM	(4) PART NUMBER	(5) DESCRIPTION AND USABLE ON CODE (UOC)	(6) QTY
51	PADZZ	81349	RCR20G102JS	RESISTOR, FIXED, COMP SERIAL NO.5-201B THRU 5-511B	1
52	PADZZ	81349	RCR20G393JS	RESISTOR, FIXED, COMP SERIAL NO.5-201B THRU 5-511B	1
53	PADZZ	81349	RC42GF104J	RESISTOR, FIXED, COMP SERIAL NO.5-201B THRU 5-511B	1
54	PADZZ	81349	RCR20G392JS	RESISTOR, FIXED, COMP SERIAL NO.5-201B THRU 5-511B	1
55	PADZZ	81349	RCR20G153JS	RESISTOR, FIXED, COMP SERIAL NO.5-201B THRU 5-511B	1
56	PADZZ	81349	RCR32G275JS	RESISTOR, FIXED, COMP SERIAL NO.5-201B THRU 5-511B	1
57	PADZZ	13715	UA78GU1C	MICROCIRCUIT, LINEAR SERIAL NO.5-201B THRU 5-511B	1
58	PADZZ	07148	80787-1	MICROCIRCUIT, DIGITA SERIAL NO.5-201B THRU 5-511B	1
59	PADZZ	81349	M38510/05101BCB	MICROCIRCUIT, DIGITA SERIAL NO.5-201B THRU 5-511B	1
60	PADZZ	81349	M38510/10901BPB	MICROCIRCUIT, LINEAR SERIAL NO.5-201B THRU 5-511B	1
61	PADZZ	82199	B161316	SWITCH, PUSH SERIAL NO.5-201B THRU 5-511B	1
63	PADZZ	13103	60308	HEATSINK SERIAL NO.5-201B THRU 5-511B	1
64	PADZZ	82199	A161517	SPACER SERIAL NO.5-201B THRU 5-511B	1
65	PADZZ	96906	MS51957-15	SCREW, MACHINE SERIAL NO.5-201B THRU 5-511B	9
66	PADZZ	96906	MS35333-70	WASHER, LOCK SERIAL NO.5-201B THRU 5-511B	11
67	PADZZ	96906	MS15795-803	WASHER, FLAT SERIAL NO.8-201B THRU 5-511B	9
68	PADZZ	96906	MS35649-244	NUT, PLAIN, HEXAGON SERIAL NO.5-201B THRU 5-511B	2
69	PADZZ	13103	1116B	HEAT SINK, ELECTRICA SERIAL NO.5-201B THRU 5-511B	2
70	PADZZ	82199	B161573	HEATSINK SERIAL NO.5-201B THRU 5-511B	1
72	PADZZ	96906	MS51957-19	SCREW, MACHINE SERIAL NO.5-201B THRU 5-511B	13
73	PADZZ	06540	8217A0440	STANDOFF, HEATSINK SERIAL NO.5-201B THRU 5-511B	1
74	PADZZ	91506	314AG39D	SOCKET, PLUG-IN ELEC SERIAL NO.5-201B THRU 5-511B	2
75	XBDZZ	82199	B161571	SPACER SERIAL NO.5-201B THRU 5-511B	1
76	XBDZZ	82199	A161474	SPACER SERIAL NO.5-201B THRU 5-511B	4
79	PADZZ	82199	B161742	HEAT SINK, ELECTRICA SERIAL NO.5-201B THRU 5-511B	1
81	XBDZZ	82199	B161572	POST, RETAINER SERIAL NO.5-201B THRU 5-511B	4
82	PAHDD	82199	D161808-1	PUSHBUTTON COMP BD SERIAL NO.5-201B THRU 5-511B	1
83	XBDZZ	82199	B161609	HV COVER SERIAL NO.5-201B THRU 5-	1

SECTION II TM11-6625-2948-24P

(1) ITEM NO	(2) SMR CODE	(3) FSCM	(4) PART NUMBER	(5) DESCRIPTION AND USABLE ON CODE (UOC)	(6) QTY
84	PADZZ	82199	A161461-1	511B PUSHBUTTON STANDOFF SERIAL NO.5- 201B THRU 5-511B	2
85	PADZZ	96906	MS51957-14	SCREW,MACHINE SERIAL NO.5-201B THRU 5-511B	3

END OF FIGURE

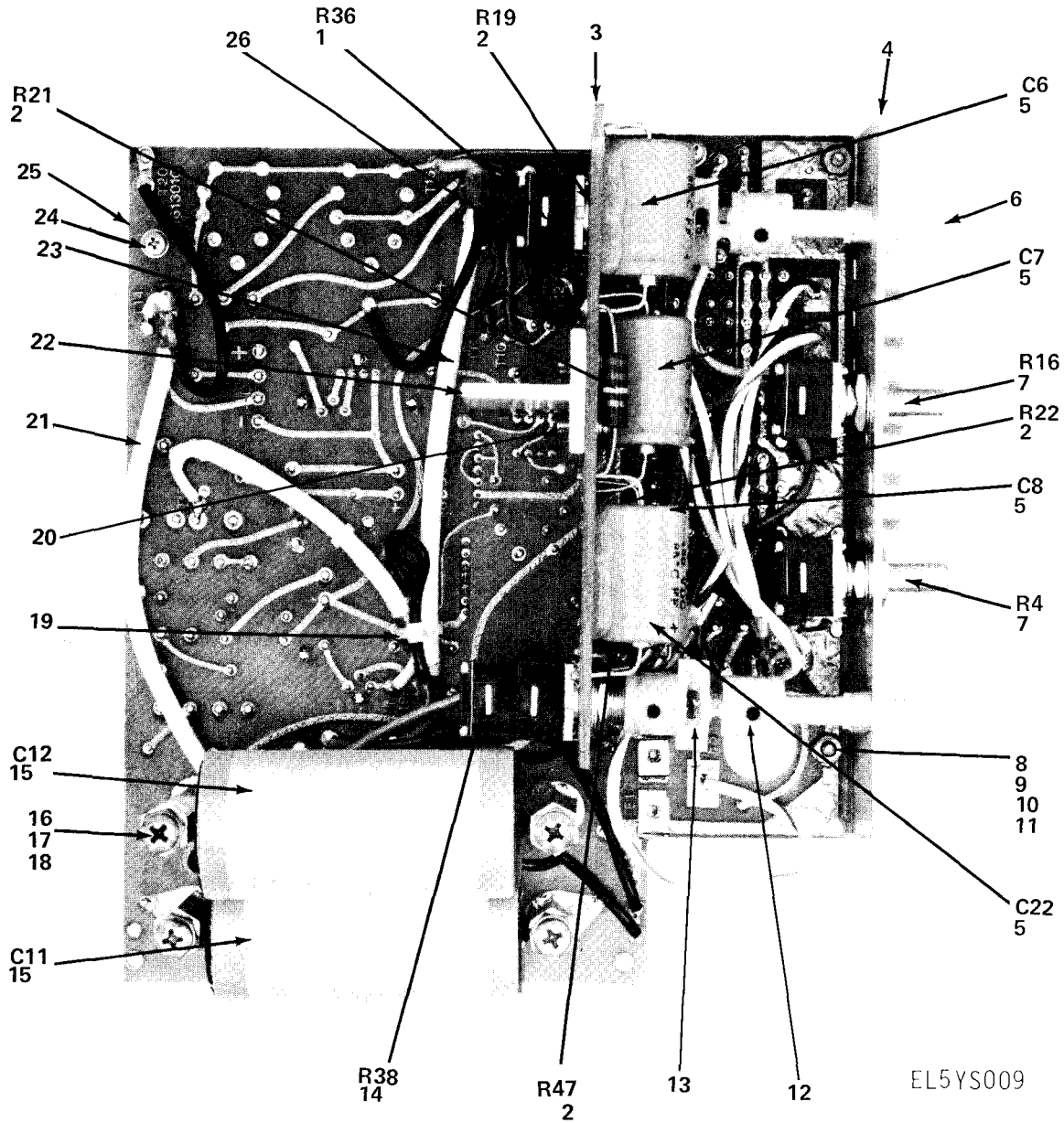

PREFIX ALL REFERENCE DESIGNATIONS WITH 1A3

BOTTOM VIEW

Figure 7. Pushbutton Board Assembly

SECTION II

TM11-6625-2948-24P

(1) ITEM NO	(2) SMR CODE	(3) FSCM	(4) PART NUMBER	(5) DESCRIPTION AND USABLE ON CODE (UOC)	(6) QTY
FIG. 7					
1	PADZZ	01121	70B1N048F103W	RESISTOR,VARIABLE,N	1
2	PADZZ	81349	RCR32G274JS	RESISTOR, FIXED, COMP	4
3	PADZZ	82199	A161449B	CAPACITOR BOARD	1
4	PADZZ	82199	B161433	BRACKET, SUPPORT	1
5	PCDZZ	14655	WBR12-450	CAPACITOR, FIXED, ELE	4
6	PADZZ	82199	A161467	SWITCH, ROD	2
7	PADZZ	01121	70B1N056P104W	RESISTOR, VARIABLE, N	2
8	PADZZ	96906	MS51957-14	SCREW, MACHINE	14
9	PADZZ	96906	MS35330-70	WASHER, LOCK	2
10	PADZZ	96906	MS15795-803	WASHER, FLAT	2
11	PADZZ	96906	MS35649-244	NUT, PLAIN, HEXAGON	2
12	PADZZ	96906	MS51021-21	SETScrew	4
13	PADZZ	82199	B161513	SHAFT, SHOULDERED	2
14	PADZZ	01121	70D1N048F253W	RESISTOR, VARIABLE, N	1
15	PADZZ	16727	A0B254-2M	CAPACITOR, FIXED, PLA	2
16	PADZZ	96906	MS51957-46	SCREW, MACHINE	4
17	PADZZ	96906	MS35338-137	WASHER, LOCK	8
18	PADZZ	96906	MS35649-284	NUT, PLAIN, HEXAGON	4
19	PADZZ	78553	C61255AA015	CLIP, WIRE RETAINER	1
20	PADZZ	96906	MS51957-3	SCREW, MACHINE	3
21	PADZZ	82199	B161516	CABLE ASSEMBLY	1
22	PADZZ	82199	B161446	SUPPORT, TEE	1
23	PADZZ	82199	B161515	CABLE ASSEMBLY	1
24	PADZZ	96906	MS51957-17	SCREW, MACHINE	2
25	XBDZZ	82199	C161301	PUSHBUTTON BD	1
26	PADZZ	78553	C61254AA015	CLAMP, CABLE, ELECTRI	1

END OF FIGURE

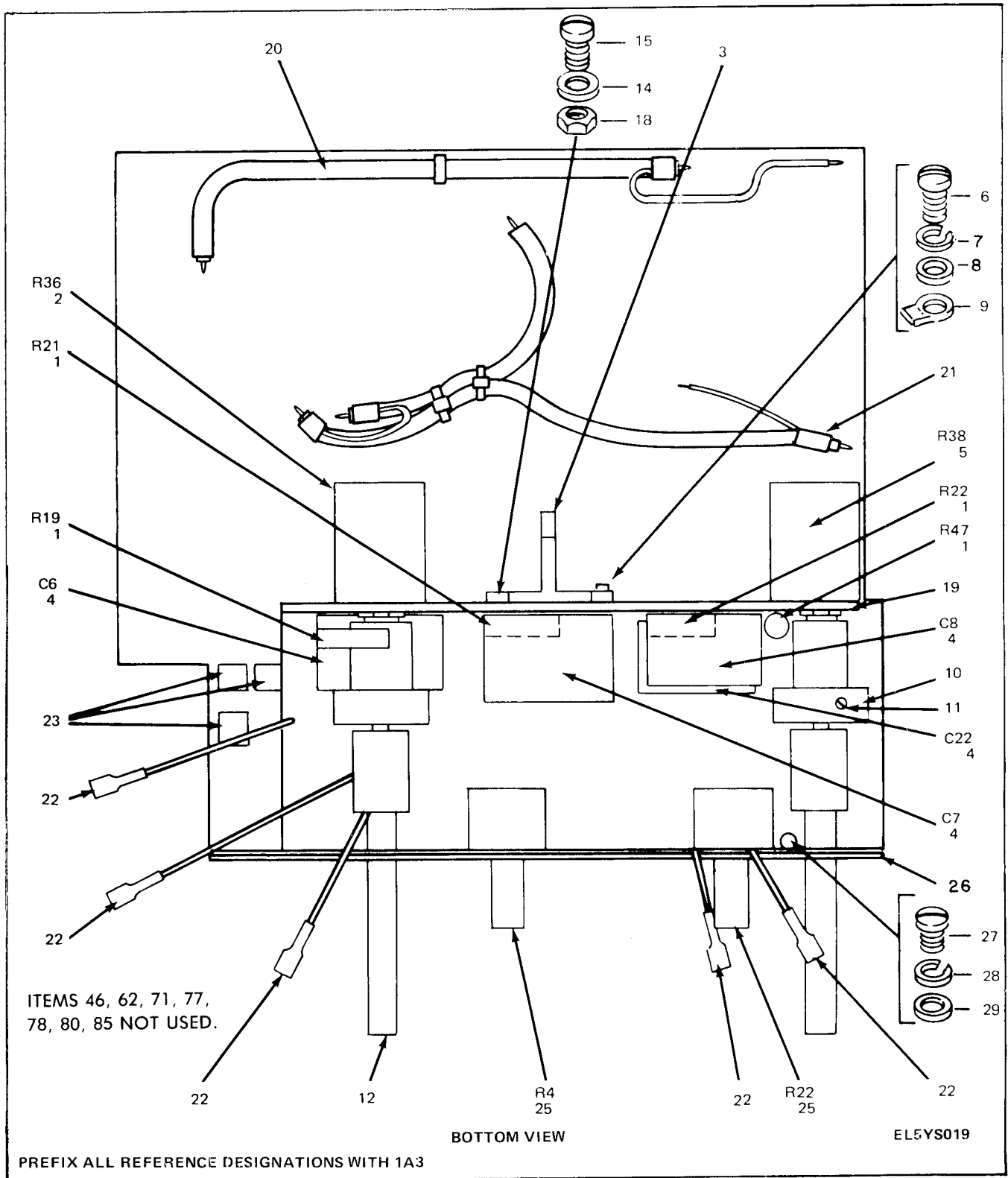

Figure 7A. Pushbutton Board Assembly, B161606-2, Serial No. 5-201B Through 5-511B.

SECTION II

TM11-6625-2948-24P

(1) ITEM NO	(2) SMR CODE	(3) FSCM	(4) PART NUMBER	(5) DESCRIPTION AND USABLE ON CODE (UOC)	(6) QTY
FIG. 7A					
1	PADZZ	81349	RCR32G274JS	RESISTOR, FIXED, COMP SERIAL NO. 5-201B THRU 5-511B	4
2	PADZZ	01121	70B1N048103W	RESISTOR, VARIABLE SERIAL NO. 5-201B THRU 5-511B	1
3	PADZZ	82199	B162078	CLIP, ELECTRICAL SERIAL NO. 5-201B THRU 5-511B	1
4	PCDZZ	14655	WBR12-450	CAPACITOR, FIXED, ELE SERIAL NO. 5-201B THRU 5-511B	4
5	PADZZ	01121	70D1N048F253W	RESISTOR, VARIABLE, N SERIAL NO. 5-201B THRU 5-511B	1
6	PADZZ	96906	MS51957-19	SCREW, MACHINE SERIAL NO. 5-201B THRU 5-511B	2
7	PADZZ	96906	MS35338-135	WASHER, LOCK SERIAL NO. 5-201B THRU 5-511B	5
8	PADZZ	96906	MS15795-805	WASHER, FLAT SERIAL NO. 5-201B THRU 5-511B	5
9	PADZZ	83330	52-1505	TERMINAL, STUD SERIAL NO. 5-201B THRU 5-511B	2
10	PADZZ	82199	B161513	SHAFT, SHOULDERED SERIAL NO. 5-201B THRU 5-511B	2
11	PADZZ	96906	MS51021-21	SETScrew SERIAL NO. 5-201B THRU 5-511B	4
12	PADZZ	82199	A161467	SWITCH, ROD SERIAL NO. 5-201B THRU 5-511B	2
14	PADZZ	06540	2363PH163	INSULATOR, WASHER SERIAL NO. 5-201B THRU 5-511B	1
15	PADZZ	96906	MS51957-16	SCREW, MACHINE SERIAL NO. 5-201B THRU 5-511B	2
18	PADZZ	80205	NAS671-4	NUT, PLAIN HEXAGON SERIAL NO. 5-201B THRU 5-511B	2
19	PADZZ	82199	B161453-1	BOARD ASSEMBLY CAP SERIAL NO. 5-201B THRU 5-511B	1
20	PADZZ	82199	B161516	CABLE ASSEMBLY SERIAL NO. 5-201B THRU 5-511B	1
21	PADZZ	82199	B161515	CABLE ASSEMBLY	1
22	PADZZ	00779	2-350800-2	TERMINAL, QUICK DISC SERIAL NO. 5-201B THRU 5-511B	5
23	PADZZ	91833	1253	SOCKET SERIAL NO. 5-201B THRU 5-511B	2
25	PADZZ	01121	70B5N056P104W	RESISTOR, VARIABLE, N SERIAL NO. 5-201B THRU 5-511B	2
26	PADZZ	82199	B161433	BRACKETT, SUPPORT SERIAL NO. 5-201B THRU 5-511B	1
27	PADZZ	96906	MS51957-3	SCREW, MACHINE SERIAL NO. 5-201B THRU	3

SECTION II TM11-6625-2948-24P

(1) ITEM NO	(2) SMR CODE	(3) FSCM	(4) PART NUMBER	(5) DESCRIPTION AND USABLE ON CODE (UOC)	(6) QTY
28	PADZZ	96906	MS35333-70	5-511B WASHER,LOCK SERIAL NO.5-201B THRU 5 -511B	7
29	PADZZ	96906	MS35333-69	WASHER,LOCK SERIAL NO.5-201B THRU 5 -511B	3

END OF FIGURE

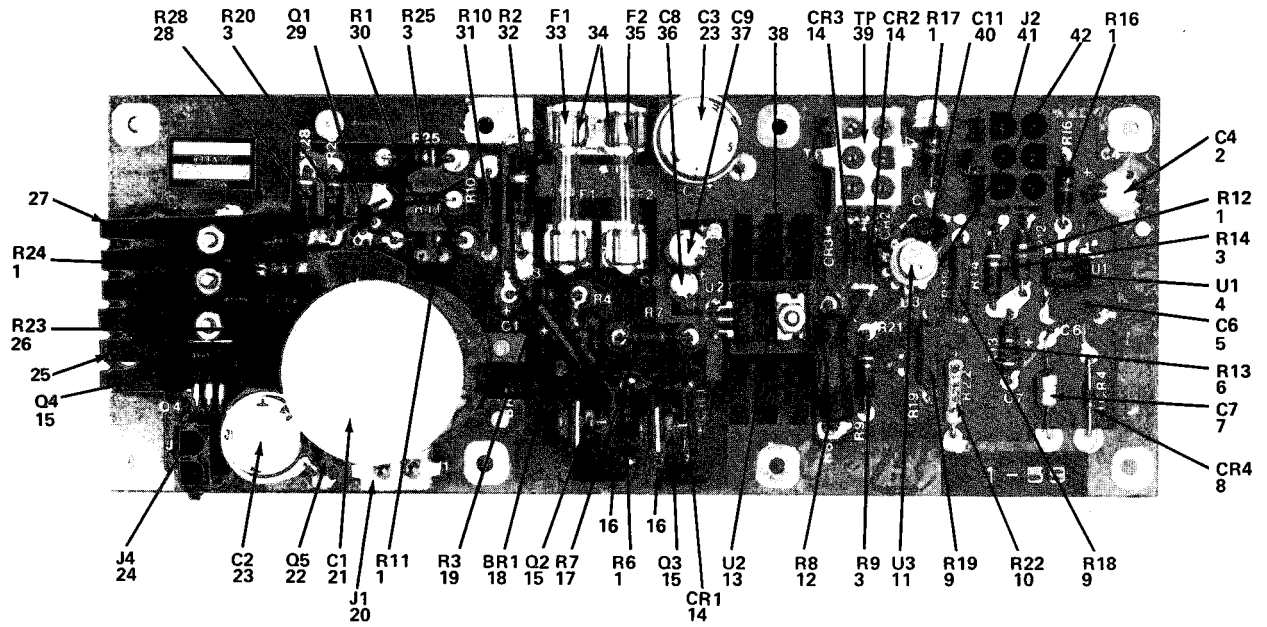

EL5YS010

Figure 8. High Voltage Control Board C161321 (Sheet 1 of 2)

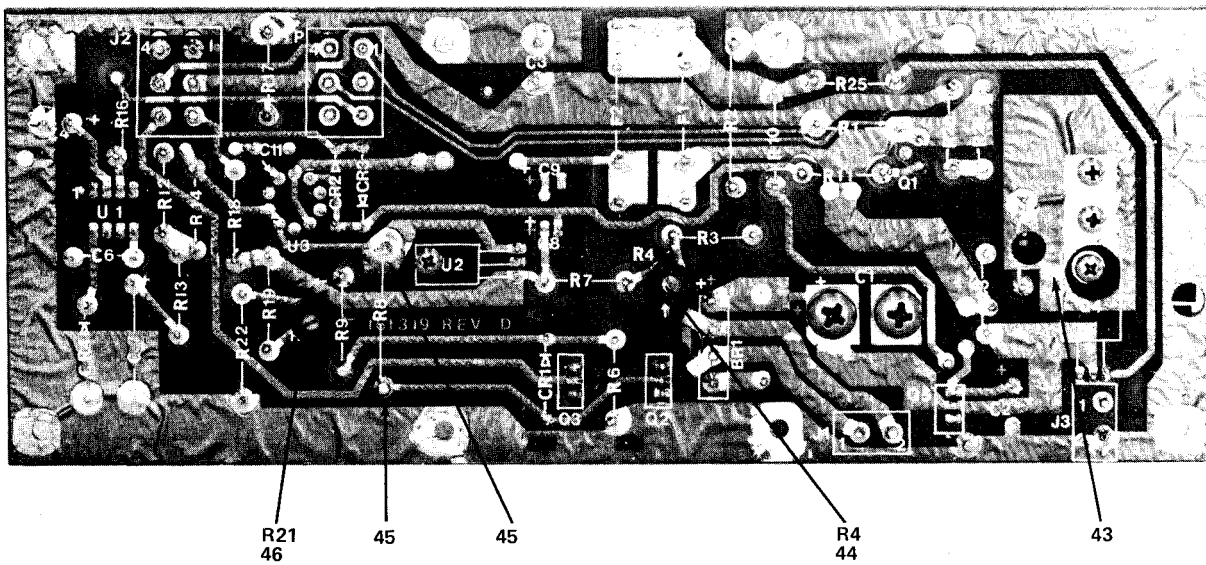

EL5YS011

Figure 8. High Voltage Control Board C161321 (Sheet 2 of 2)

SECTION II

TM11-6625-2948-24P

(1) ITEM NO	(2) SMR CODE	(3) FSCM	(4) PART NUMBER	(5) DESCRIPTION AND USABLE ON CODE (UOC)	(6) QTY
GROUP. 0102 HIGH VOLTAGE CONTROL BOARD C161321					
FIG. 8					
1	PADZZ	81349	RCR20G103JS	RESISTOR, FIXED, COMP	6
2	PADZZ	56289	503D107M025ML	CAP, FXD, ELECT	1
3	PADZZ	81349	RCR20G102JS	RESISTOR, FIXED, COMP	4
4	PADZZ	81349	M38510/10901BPB	MICROCIRCUIT, LINEAR	1
5	PADZZ	73445	C280AE/A100K	CAPACITOR, FIXED MET	1
6	PADZZ	81349	RCR20G475JS	RESISTOR, FIXED, COMP	1
7	PADZZ	56289	162D0106X9020DD2	CAP, FXD, ELECT	1
8	PADZZ	81349	JAN1N4467	SEMICONDUCTOR DEVIC	1
9	PADZZ	81349	RNC65H1002FS	RESISTOR, FIXED, FILM	2
10	PADZZ	81349	RNC65H5621FS	RESISTOR, FIXED, FILM	1
11	PADZZ	34148	U5R7723312	MICROCIRCUIT, LINEAR	1
12	PADZZ	63743	5XM180WL	RESISTOR, FIXED, WIRE	1
13	PADZZ	04713	MC78M20CT	MICROCIRCUIT, LINEAR	1
14	PADZZ	81349	1N456	SEMICONDUCTOR DEVIC	3
15	PADZZ	89536	325720	TRANSISTOR	3
16	PADZZ	13103	6030B	HEAT SINK, ELECTRICA	2
17	PADZZ	81349	RCR20G122JS	RESISTOR, FIXED, COMP	1
18	PADZZ	04713	MDA920A3	RECTIFIER, SEMICONDU	1
19	PADZZ	81349	RCR20G201JS	RESISTOR, FIXED, COMP	1
20	PADZZ	00779	350786-1	CONNECTOR, PLUG, ELEC	1
21	PADZZ	56699	8F556M1	CAPACITOR	1
22	PADZZ	80131	2N5190	TRANSISTOR	1
23	PADZZ	56289	503D477M063QE	CAP, FXD, ELECT	2
24	PADZZ	00779	350428-1	CONNECTOR, PLUG, ELEC	1
25	PADZZ	13103	6071B	HEAT SINK, ELECTRICA	1
26	PADZZ	81349	RCR20G151JS	RESISTOR, FIXED, COMP	1
27	PADZZ	13103	6072B	HEAT SINK, ELECTRICA	1
28	PADZZ	81349	RCR20G202JS	RESISTOR, FIXED, COMP	1
29	PADZZ	80131	2N4402	TRANSISTOR	1
30	PADZZ	81349	RWR80SR200FS	RESISTOR, FIXED, WIRE	1
31	PADZZ	81349	RCR20G271JS	RESISTOR, FIXED, COMP	1
32	PADZZ	81349	RCR32G150JS	RESISTOR, FIXED, COMP	1
33	PADZZ	81349	F02A250V1/4A	FUSE, CARTRIDGE	1
34	PADZZ	75915	102074	CLIP, ELECTRICAL	4
35	PADZZ	81349	F02A250V2-1-2A	FUSE, CARTRIDGE	1
36	PCDZZ	55680	35U10	CAPACITOR, FIXED, ELE	1
37	PADZZ	81349	CMR05F910G0DR	CAPACITOR, FIXED, MIC	1
38	PADZZ	13103	6063B	HEAT SINK, ELECTRICA	1
39	PADZZ	00779	350431-1	CONNECTOR, RECEPTAC	1
40	PADZZ	56289	503D226M050LA	CAP, FXD, ELECT	1
41	PADZZ	00779	350711-1	CONNECTOR, PLUG, ELEC	1
42	PADZZ	91506	8058-24G1	SOCKET, PLUG-IN ELEC	1
43	PADZZ	82199	C161319	CIRCUIT CARD ASSEMB	1
44	PADZZ	32997	3339H-1-501	RESISTOR, VARIABLE, N CONTROL	BIAS ADJUST 1
45	XBDZZ	71279	1028-1	TERMINAL, STUD	2
46	PADZZ	80294	3339H-1-102	RESISTOR, VARIABLE, N	HV ADJUST 1

SECTION II

TM11-6625-2948-24P

(1) ITEM NO	(2) SMR CODE	(3) FSCM	(4) PART NUMBER	(5) DESCRIPTION AND USABLE ON CODE (UOC) CONTROL	(6) QTY
-------------------	--------------------	-------------	-----------------------	--	------------

END OF FIGURE

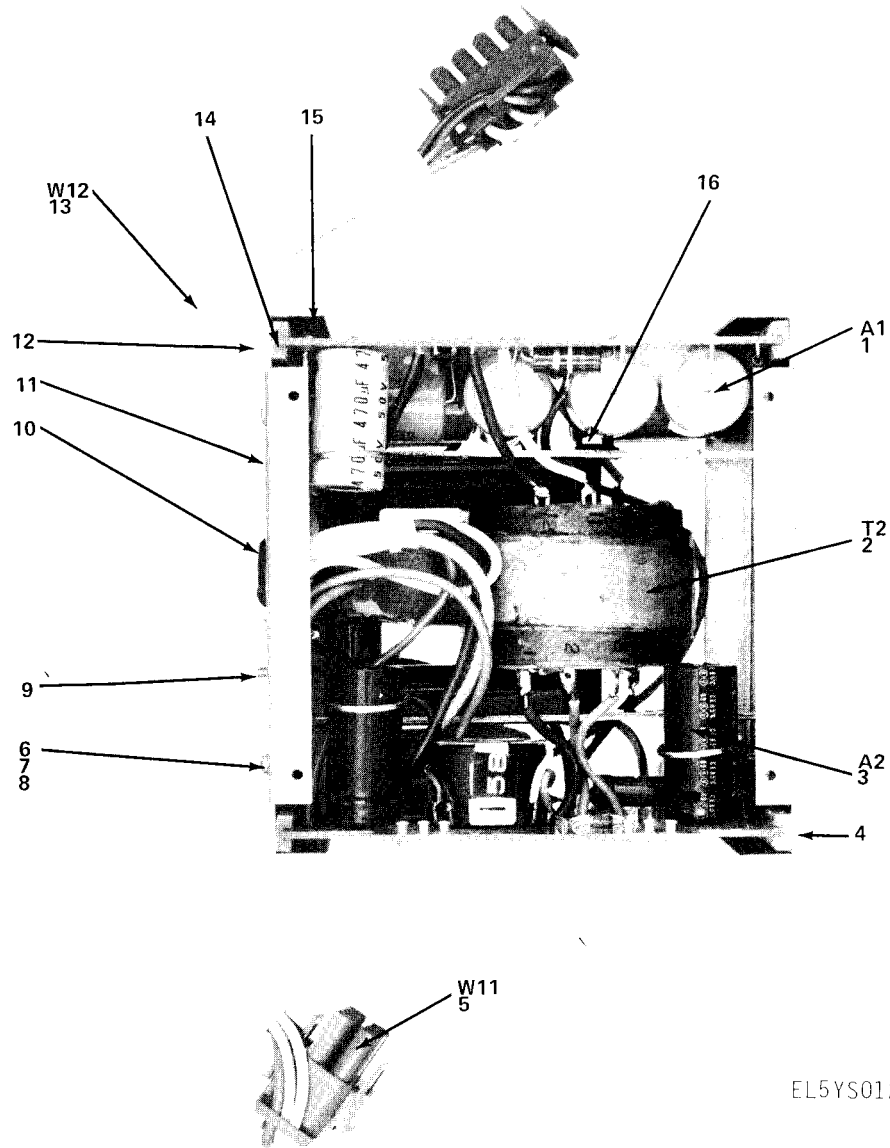

PREFIX ALL REFERENCE DESIGNATIONS WITH 1A5

Figure 9. High Voltage Box D161309

SECTION II

TM11-6625-2948-24P

(1) ITEM NO	(2) SMR CODE	(3) FSCM	(4) PART NUMBER	(5) DESCRIPTION AND USABLE ON CODE (UOC)	(6) QTY
GROUP 0103 HIGH VOLTAGE BOX D161309					
FIG. 9					
1	PAHDD	82199	C161443-2	COMP BD ASSY HV.PS	1
2	PADZZ	82199	C161313	TRANSFORMER,POWER	1
3	PAHDD	82199	B161444	MASTER OSC BOARD	1
4	XBDZZ	82199	C161419-1	PANEL, SIDE	1
5	PADZZ	82199	B161490	CABLE ASSEMBLY	1
6	PADZZ	96906	MS51957-19	SCREW, MACHINE	4
7	PADZZ	96906	MS35338-135	WASHER, LOCK	8
8	PADZZ	96906	MS15795-803	WASHER, FLAT	4
9	PADZZ	73734	23021	SCREW MACHINE	1
10	PADZZ	83330	2175	GROMMET, NOMETALLIC	2
11	XBDZZ	82199	C161419-2	PANEL, SIDE	1
12	PADZZ	96906	MS51957-14	SCREW, MACHINE	6
13	PADZZ	82199	B161491	CABLE ASSEMBLY	1
14	PADZZ	18677	23071-2	GUIDE, SNAP-IN	4
15	XBDZZ	82199	C161450	BASE	1
16	PADZZ	96906	MS77068-1	TERMINAL, LUG	1
END OF FIGURE					

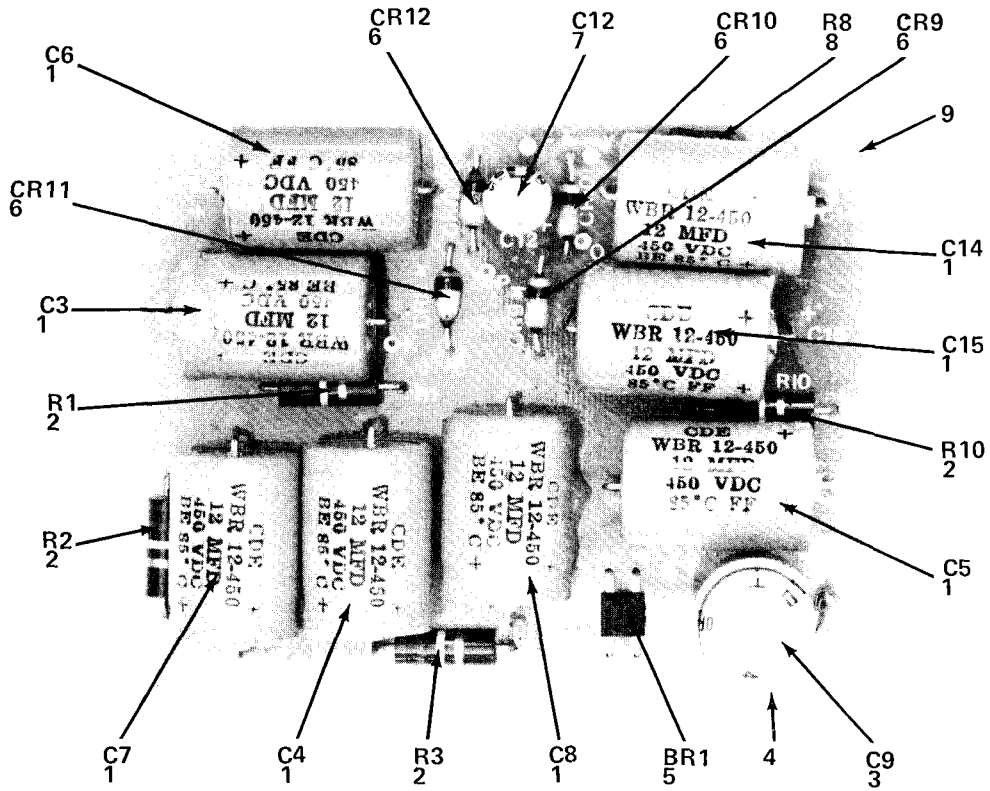

EL5YS01J

PREFIX ALL REFERENCE DESIGNATIONS WITH 1A5A1

Figure 10. High Voltage General Component Assembly

SECTION II

TM11-6625-2948-24P

(1) ITEM NO	(2) SMR CODE	(3) FSCM	(4) PART NUMBER	(5) DESCRIPTION AND USABLE ON CODE (UOC)	(6) QTY
				GROUP. 010301 HIGH VOLTAGE GENERAL COMPONENT ASSEMBLY	
				FIG. 10	
1	PCDZZ	14655	WBR12-450	CAPACITOR, FIXED, ELE	8
2	PADZZ	81349	RCR20G274JS	RESISTOR, FIXED, COMP	4
3	PADZZ	56289	503D477F050QG	CAPACITOR, FIXED, ELE	1
4	PADZZ	82199	A161457-1	CAPACITOR	1
5	PADZZ	04713	MDA920A3	RECTIFIER, SEMICONDU	1
6	PADZZ	14099	SH30F	SEMICONDUCTOR DEVIC	4
7	PADZZ	56289	503D107G0	CAP, FXD, ELECT	1
8	PADZZ	00213	3005-100-3W	RESISTOR	1
9	XADZZ	82199	C161439	CIRCUIT CARD ASSEMB	1
				END OF FIGURE	

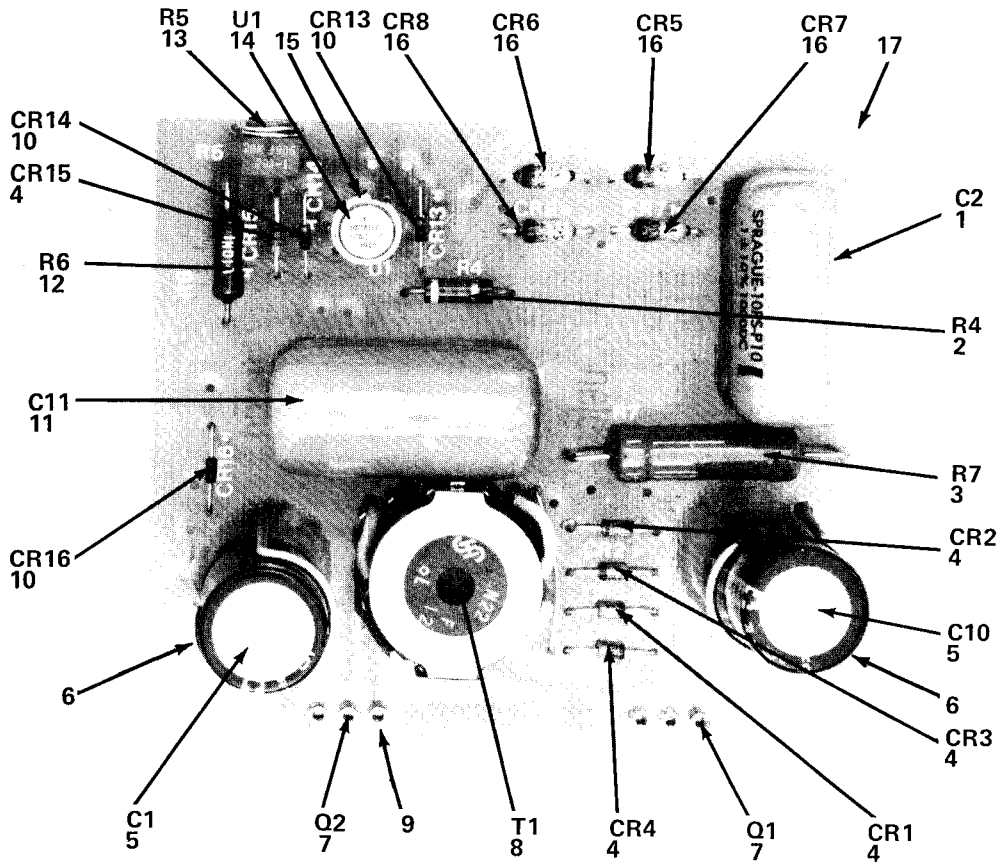

EL5YS014

PREFIX ALL REFERENCE DESIGNATIONS WITH 1A5A2

Figure 11. Master Oscillator Board Assembly

SECTION II

TM11-6625-2948-24P

(1) ITEM NO	(2) SMR CODE	(3) FSCM	(4) PART NUMBER	(5) DESCRIPTION AND USABLE ON CODE (UOC)	(6) QTY
GROUP. 0104 MASTER OSCILLATOR ASSEMBLY					
FIG. 11					
1	PADZZ	56289	10PS-P10	CAPACITOR, FIXED, PLA	1
2	PADZZ	81349	RCR20G471JS	RESISTOR, FIXED, COMP	1
3	PADZZ	75042	CGH2-105F	RESISTOR, FIXED, FILM	1
4	PADZZ	81349	JAN1N4476	SEMICONDUCTOR DEVIC	5
5	PADZZ	56289	503D477M063QE	CAP, FXD, ELECT	2
6	PADZZ	82199	A161457-1	CAPACITOR	2
7	PADZZ	81349	JAN2N5998	TRANSISTOR	2
8	PADZZ	82199	A161314	TRANSFORMER, POWER	1
9	PADZZ	00799	380-635-2	RECEPTACLE, COMPONEN	6
10	PADZZ	81349	1N456	SEMICONDUCTOR DEVIC	3
11	PADZZ	56289	16PS-S50	CAPACITOR, FIXED, CER	1
12	PADZZ	81349	RW69V471	RESISTOR, FIXED, WIRE	1
13	PADZZ	80294	3339H-1-203	RESISTOR, VARIABLE, N CONTROL	1
14	PADZZ	01295	SN72741L	MICROCIRCUIT, LINEAR	1
15	PADZZ	71785	133-98-92-061	SOCKET, PLUG-IN ELEC	1
16	PADZZ	4099	SH30F	SEMICONDUCTOR DEVIC	4
17	XADZZ	82199	B161440	PC BOARD	1

END OF FIGURE

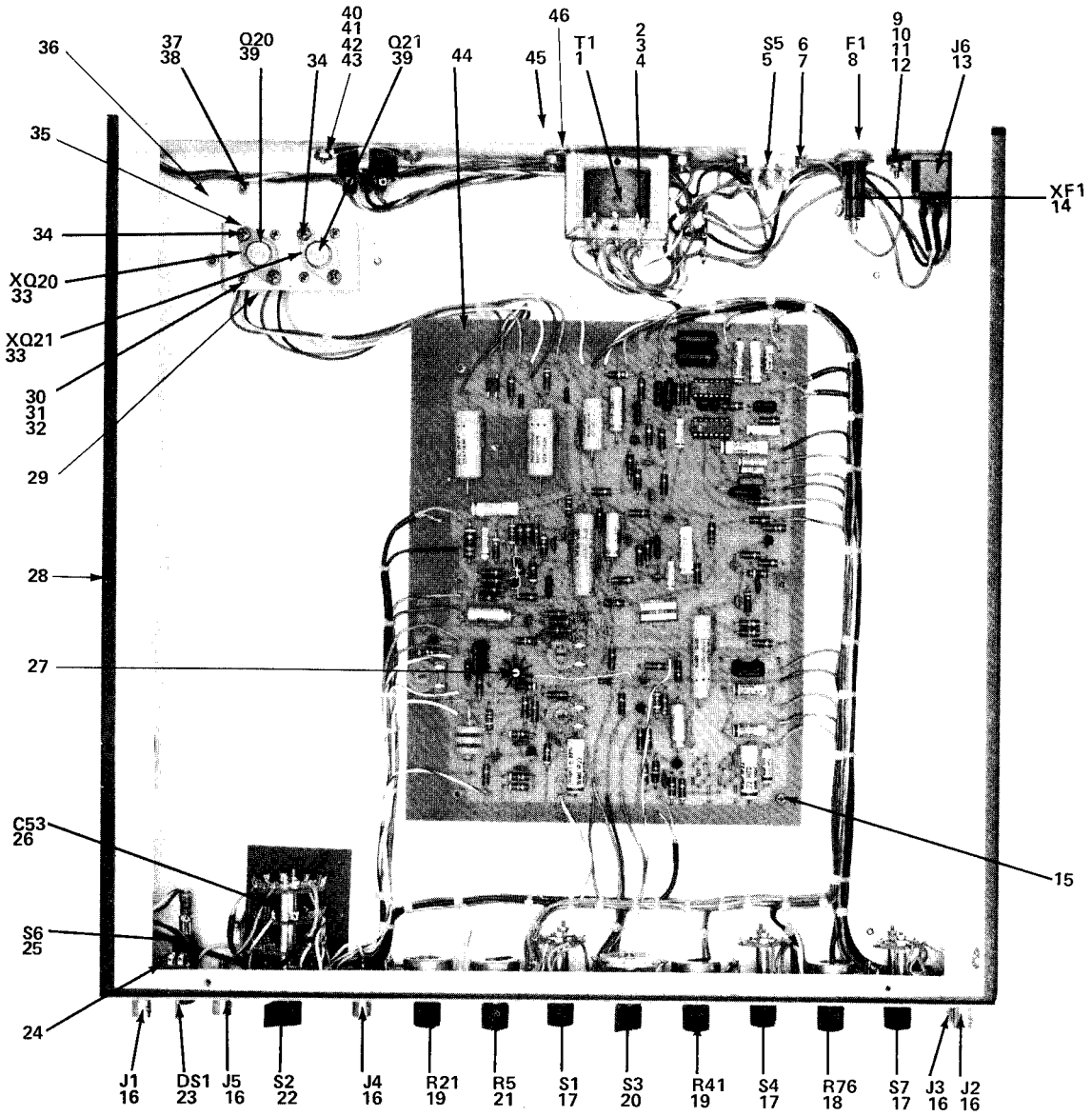

PREFIX ALL REFERENCE DESIGNATIONS WITH 2

Figure 12. Modulator MD-1075/URM

(1) ITEM NO	(2) SMR CODE	(3) FSCM	(4) PART NUMBER	(5) DESCRIPTION AND USABLE ON CODE (UOC)	(6) QTY
GROUP. 02 MODULATOR MD-1075/URM					
FIG. 12					
1	PADZZ	82199	B165928	TRANSFORMER, POWER	1
2	PADZZ	96906	MS35190-222	SCREW, MACHINE	1
3	PADZZ	96906	MS35330-70	WASHER, LOCK	1
4	PADZZ	96906	MS35649-244	NUT, PLAIN, HEXAGON	1
5	PADZZ	82389	46206LFR	SWITHC, SLIDE	1
6	PADZZ	96906	MS51957-19	SCREW, MACHINE	2
7	PADZZ	96906	MS35649-244	NUT, PLAIN, HEXAGON	2
8	PADZZ	81349	F02A250V1/4A	FUSE, CARTRIDGE	1
9	PADZZ	96906	MS15795-803	WASHER, FLAT	2
10	PADZZ	96906	MS51957-15	SCREW, MACHINE	2
11	PADZZ	96906	MS35330-70	WASHER, LOCK	2
12	PADZZ	96906	MS35649-244	NUT, PLAIN, HEXAGON	2
13	PADZZ	16428	17252	CONNECTOR, RECEPACL	1
14	PADZZ	75915	341001	FUSEHOLDER, EXTRACTO	1
15	XADZZ	96906	MS51957-19	SCREW, MACHINE	6
16	PADZZ	81349	M39012/21-0001	CONNECTOR, RECEPACL	5
17	PADZZ	82199	A165995	SWITCH, ROTARY	3
18	PADZZ	75042	PQ11-123	RESISTOR, VARIABLE, N	1
19	PADZZ	75042	PQ11-120	RESISTOR, VARIABLE, N	2
20	PADZZ	71450	13604-1	SWITCH, ROTARY	1
21	PADZZ	11236	BA30397	RESISTOR, VARIABLE, N	1
22	PADZZ	71590	PA1021	SWITCH, ROTARY	1
23	PADZZ	95263	32-1111T	LIGHT, INDICATOR	1
24	PADZZ	80063	SM-B-603975	TERMINAL, LUG	1
25	PADZZ	96906	MS75029-23	SWITCH, TOGGLE	1
26	PADZZ	71590	DD6-103	CAPACITOR FIXED CE	1
27	PADZZ	82199	A165693	HEAT SINK, SOLDERING	1
28	PADZZ	82199	D165834	CHASSIS, MODULATOR	1
29	PADZZ	97046	201CB	HEATSINK	1
30	PADZZ	96906	MS51957-14	SCREW, MACHINE	4
31	PADZZ	96906	MS35330-70	WASHER, LOCK	4
32	PADZZ	96906	MS35649-244	NUT, PLAIN, HEXAGON	4
33	PADZZ	91833	4615	SOCKET, PLUG-IN ELEC	2
34	PADZZ	96906	MS51957-27	SCREW, MACHINE	4
35	PADZZ	97046	292AP	HEATSINK	2
36	XBDZZ	82199	B165930	PANEL, TOP	1
37	PADZZ	96906	MS24693C2	SCREW, MACHINE	2
38	PADZZ	96906	MS35333-70	WASHER, LOCK	2
39	PADZZ	49671	40312	TRANSISTOR	2
40	PADZZ	96906	MS51957-27	SCREW, MACHINE	2
41	PADZZ	96906	MS21044B06	NUT, SELF-LOCKING, HE	2
42	PADZZ	96906	MS15795-803	WASHER, FLAT	6
43	PADZZ	96906	MS35330-70	WASHER, LOCK	6
44	PADZZ	82199	C166601	MODULATOR PC BD	1
45	PADZZ	82199	D165834	CHASSIS, MODULATOR	1
46	PADZZ	71785	332-14-08-042	TERMINAL BOARD	1

END OF FIGURE

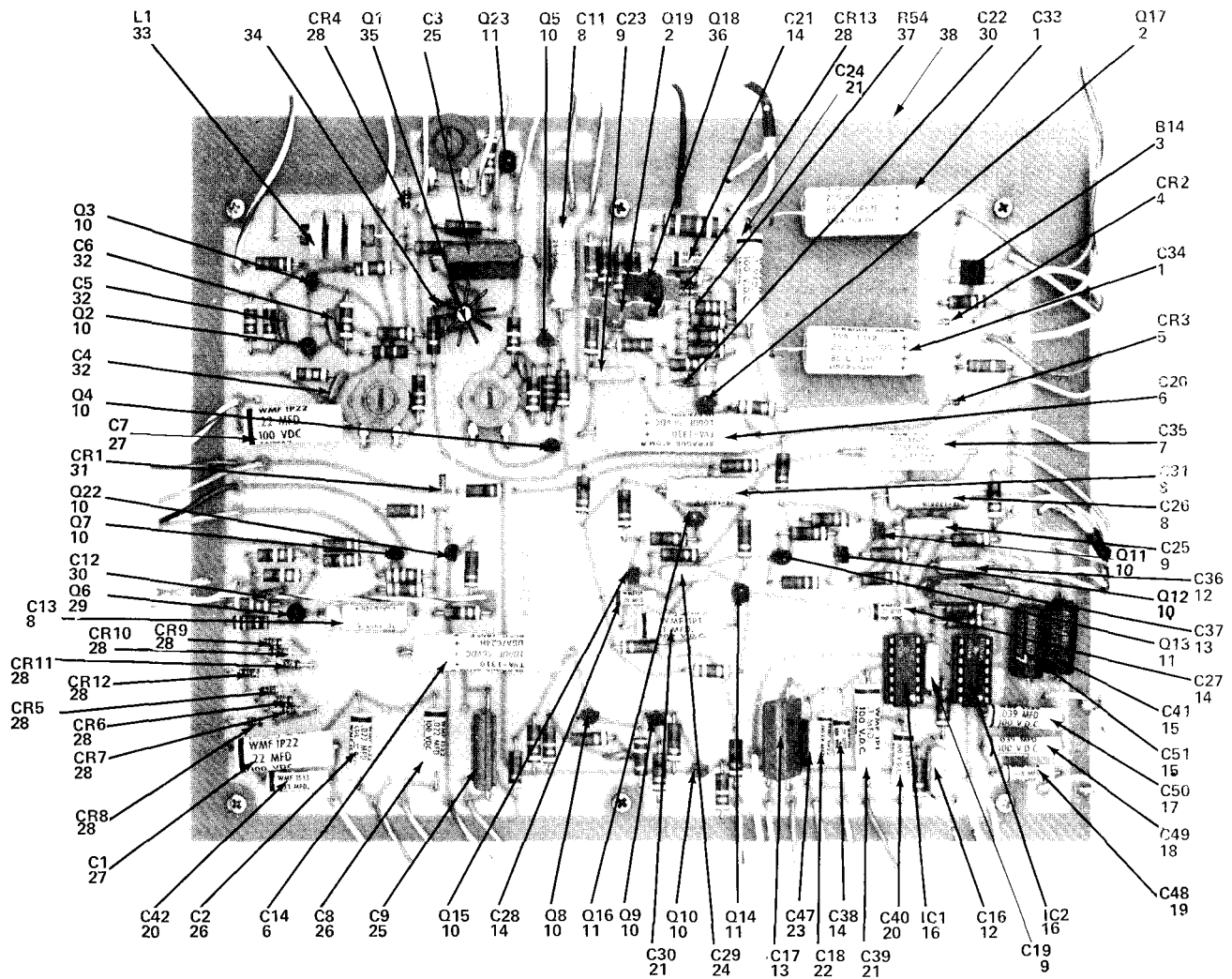

EL5YS016

PREFIX ALL REFERENCE DESIGNATIONS WITH 2A1

Figure 13. Modulator Board Assembly

SECTION II

TM11-6625-2948-24P

(1) ITEM NO	(2) SMR CODE	(3) FSCM	(4) PART NUMBER	(5) DESCRIPTION AND USABLE ON CODE (UOC)	(6) QTY
FIG. 13					
1	PADZZ	96795	243037-257	CAPACITOR, FIXED, ELE	2
2	PADZZ	81349	JAN2N3904	TRANSISTOR	2
3	PADZZ	04713	MDA920A3	RECTIFIER, SEMICONDU	1
4	PADZZ	81349	JAN1N4477	SEMICONDUCTOR DEVIC	1
5	PADZZ	80131	1N5233B	SEMICONDUCTOR DEVIC	1
6	PADZZ	81349	M39018/01-1036M	CAPACITOR, FIXED, ELE	2
7	PADZZ	56289	TVA1102	CAPACITOR, FIXED, ELE	1
8	PADZZ	56289	TEL305-5	CAPACITOR, FIXED, ELE	4
9	PADZZ	81349	CM15FD151G03	CAPACITOR, FIXED, MIC	3
10	PADZZ	34148	2N4400	TRANSISTOR	13
11	PADZZ	80131	2N4402	TRANSISTOR	4
12	PADZZ	81349	CM15FD101G03	CAPACITOR, FIXED, MIC	2
13	PADZZ	81349	CM30E122J	CAPACITOR, FIXED, MIC	2
14	PADZZ	81349	CTM103VAJ	CAPACITOR, FIXED, PLA	4
15	PADZZ	81349	M39003/01-3003	CAPACITOR, FIXED, ELE	2
16	PADZZ	81349	M38510/01201BCB	MICROCIRCUIT, DIGITA	2
17	PADZZ	81349	CTM393VAJ	CAPACITOR, FIXED, PLA	1
18	PADZZ	14655	WMF1S47	CAPACITOR, FIXED, PLA	1
19	PADZZ	14655	WMF1S18J	CAPACITOR, FIXED, PLA	1
20	PADZZ	81349	CTM333VAJ	CAPACITOR, FIXED, PLA	2
21	PADZZ	81349	CTM104VAJ	CAPACITOR, FIXED, PLA	3
22	PADZZ	81349	CTM332VBJ	CAPACITOR, FIXED, PLA	1
23	PADZZ	81349	CM15E910J	CAPACITOR, FIXED, MIC	1
24	PADZZ	81349	CM15ED470GP3	CAPACITOR, FIXED, MIC	1
25	PADZZ	81349	CM30FD202G03	CAPACITOR, FIXED, MIC	2
26	PADZZ	81349	CTM223VAJ	CAPACITOR, FIXED, PLA	2
27	PADZZ	14655	WMF1P22	CAPACITOR, FIXED, PLA	2
28	PADZZ	81349	JAN1N914	SEMICONDUCTOR DEVIC	10
29	PADZZ	27622	2N4304	TRANSISTOR	1
30	PADZZ	81349	CK60BX470K	7CAPACITOR, FIXED, CE	2
31	PADZZ	81349	1N5240B	SEMICONDUCTOR, DEVIC	1
32	PADZZ	71590	DD102	CAPACITOR, FIXED, CER	3
33	PADZZ	76493	4652	COIL, RADIO FREQUENC	1
34	PADZZ	91506	314-AG39D	SOCKET, PLUG-IN ELEC	2
35	35	13688	2N2646	TRANSISTOR	1
36	35	80131	2N3906	TRANSISTOR	1
37	PADZZ	81349	RCR20G4R7JS	RESISTOR, FIXED, COMP	1
38	PADZZ	82199	B165832	PC BOARD	1

END OF FIGURE

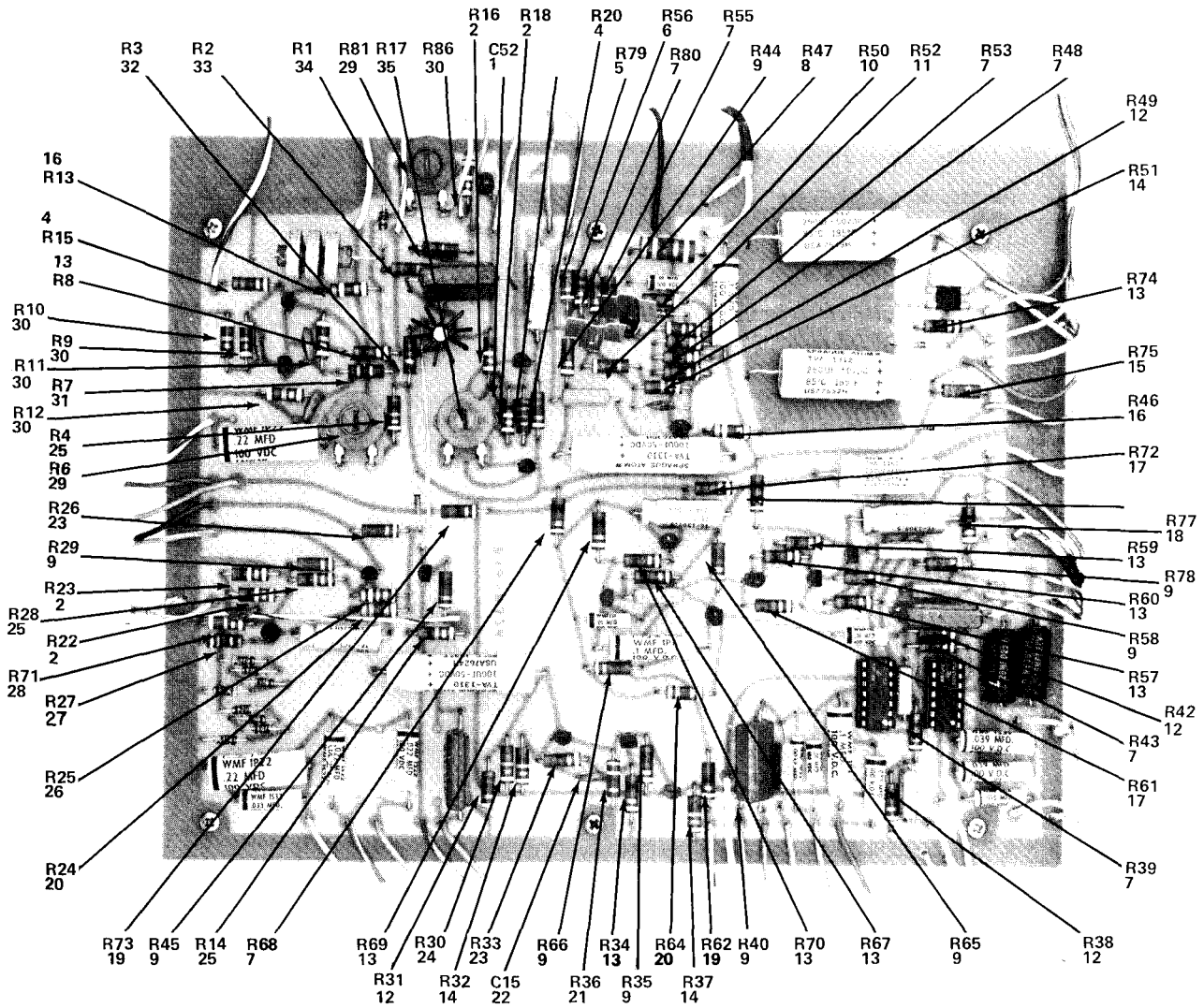

EL5YS017

PREFIX ALL REFERENCE DESIGNATIONS WITH 2A1

Figure 14. Modulator Board Assembly, Resistors and Capacitors

(1) ITEM NO	(2) SMR CODE	(3) FSCM	(4) PART NUMBER	(5) DESCRIPTION AND USABLE ON CODE (UOC)	(6) QTY
FIG. 14					
1	PADZZ	71590	DD330	CAPACITOR, FIXED, CER	1
2	PADZZ	81349	RCR20G104JS	RESISTOR, FIXED, COMP	4
3	PADZZ	81349	RCR20G565JS	RESISTOR, FIXED, COMP	1
4	PADZZ	81349	RCR20G682JS	RESISTOR, FIXED, COMP	2
5	PADZZ	81349	RCR20G472JS	RESISTOR, FIXED, COMP	1
6	PADZZ	81349	RCR20G100JS	RESISTOR, FIXED, COMP	1
7	PADZZ	81349	RCR20G101JS	RESISTOR, FIXED, COMP	8
8	PADZZ	81349	RCR32G331JS	RESISTOR, FIXED, COMP	1
9	PADZZ	81349	RCR20G152JS	RESISTOR, FIXED, COMP	9
10	PADZZ	81349	RCR20G202JS	RESISTOR, FIXED, COMP	1
11	PADZZ	81349	RCR20G911JS	RESISTOR, FIXED, COMP	1
12	PADZZ	81349	RCR20G122JS	RESISTOR, FIXED, COMP	4
13	PADZZ	81349	RCR20G102JS	RESISTOR, FIXED, COMP	9
14	PADZZ	81349	RCR20G153JS	RESISTOR, FIXED, COMP	3
15	PADZZ	81349	RCR20G182JS	RESISTOR, FIXED, COMP	1
16	PADZZ	81349	RCR20G392JS	RESISTOR, FIXED, COMP	2
17	PADZZ	81349	RCR20G221JS	RESISTOR, FIXED, COMP	2
18	PADZZ	81349	RCR20G204JS	RESISTOR, FIXED, COMP	1
19	PADZZ	81349	RCR20G510JS	RESISTOR, FIXED, COMP	2
20	PADZZ	81349	RCR20G332JS	RESISTOR, FIXED, COMP	2
21	PADZZ	81349	RCR20G391JS	RESISTOR, FIXED, COMP	1
22	PADZZ	81349	CK60BX100K	CAPACITOR, FIXED, CER	1
23	PADZZ	81349	RCR20G222JS	RESISTOR, FIXED, COMP	2
24	PADZZ	81349	RCR20G513JS	RESISTOR, FIXED, COMP	1
25	PADZZ	81349	RCR20G103JS	RESISTOR, FIXED, COMP	3
26	PADZZ	81349	RCR20G393JS	RESISTOR, FIXED, COMP	1
27	PADZZ	81349	RCR20G471JS	RESISTOR, FIXED, COMP	1
28	PADZZ	81349	RCR20G474JS	RESISTOR, FIXED, COMP	1
29	PADZZ	71450	U201R253B	RESISTOR, VARIABLE, N	
30	PADZZ	81349	RCR20G473JS	RESISTOR, FIXED, COMP	6
31	PADZZ	81349	RCR20G272JS	RESISTOR, FIXED, COMP	1
32	PADZZ	81349	RCR20G681JS	RESISTOR, FIXED, COMP	1
33	PADZZ	81349	RCR20G68566	RESISTOR, FIXED, COMP UOC:DTW	1
34	PADZZ	81349	RCR20G560JS	RESISTOR, FIXED, COMP UOC:DTW	1
35	PADZZ	71450	U201R194B	RESISTOR, VARIABLE, N UOC:DTW	1

END OF FIGURE

NATIONAL STOCK NUMBER AND PART NUMBER INDEX

STOCK NUMBER	NATIONAL STOCK NUMBER INDEX		STOCK NUMBER	FIG.	ITEM
	FIG.	ITEM			
5910-00-007-2002	14	15	5905-00-104-8336	6A	36
5960-00-011-9144	3	81	5905-00-104-8345	15	34
5910-00-023-9868	7	15	5905-00-104-8348	15	20
5930-00-043-1378	5	3	5905-00-104-8350	15	17
	13	5	5905-00-106-1273	6	1
5920-00-043-2641	1	11		15	14
	3	47		6A	55
	8	33	5905-00-106-1274	15	11
	13	8	5905-00-106-1276	6	36
5305-00-054-5637	7	20		6A	41
	7A	27	5905-00-106-9344	15	7
5305-00-054-5648	3	14	5905-00-108-6922	8	26
	7	8	5905-00-110-0196	6	47
	9	12		8	3
	13	30		15	13
	6A	85		6A	51
5305-00-054-5649	3	51	5905-00-110-0310	6	12
	6	10		15	16
	13	10		6A	54
	6A	65	5905-00-111-4738	6	60
5305-00-054-5650	4	31		15	9
	5	7	5905-00-111-4742	15	21
	4A	15	5905-00-111-4858	11	2
5305-00-054-5651	7	24		15	27
5305-00-054-6649	3	38	5905-00-111-8357	15	32
5305-00-054-6650	3	78	5935-00-111-8546	8	42
5305-00-054-6651	13	34	5905-00-114-5393	6	59
	13	40		6A	45
5305-00-054-6653	2	17	5905-00-114-5407	8	31
5305-00-054-6654	3	8		6A	50
	3	70	5905-00-114-5416	6	25
5305-00-054-6668	6	69		10	2
5305-00-054-6670	3	63		6A	43
5305-00-054-6672	3	25	5905-00-114-5438	15	19
5305-00-054-6676	4	19	5905-00-116-8560	15	18
5305-00-059-3663	1	20	5920-00-122-0315	3	49
5305-00-059-3664	3	60		6	8
5910-00-071-9922	8	5	5905-00-126-6705	14	37
5961-00-078-6727	13	39	5905-00-138-4927	6	13
5961-00-079-6881	6	16		6A	38
	6A	22	5910-00-138-6964	14	24
5905-00-088-0635	11	12	5905-00-141-0592	8	17
5961-00-098-8669	11	4		15	12
	6A	21	5905-00-141-0593	15	15
5905-00-104-5755	15	6	5905-00-141-0595	15	5
5905-00-104-5756	6	18	5905-00-141-0596	15	30
	6A	37	5905-00-141-0597	15	24
5905-00-104-8332	8	6	5905-00-141-0599	6	11
5905-00-104-8336	6	14		15	26
	15	2		6A	52

NATIONAL STOCK NUMBER AND PART NUMBER INDEX

STOCK NUMBER	NATIONAL STOCK NUMBER INDEX		STOCK NUMBER	FIG.	ITEM
	FIG.	ITEM			
5905-00-141-0723	6	9	5961-00-443-9747	6	6
5905-00-141-0727	8	19		6A	34
5905-00-141-1071	6	39	5961-00-444-6607	14	5
	15	28	5961-00-450-3040	8	29
	6A	40		14	11
5905-00-141-1130	15	31	5910-00-463-8046	14	19
5905-00-141-1165	15	4	5910-00-463-9490	6	43
5905-00-141-1168	15	23		6A	5
5961-00-147-9600	6	58	5961-00-477-1248	14	29
	8	8	5905-00-482-0791	8	10
	6A	15	5905-00-483-7415	8	12
5905-00-147-9844	6	41	5905-00-484-0275	6A	56
5910-00-163-4071	14	8	5961-00-497-4280	8	15
5355-00-172-2466	2	6	5935-00-498-4733	5	8
5940-00-192-9962	13	46	5961-00-499-7909	6	35
5310-00-208-9255	2	12		6A	18
5920-00-227-6179	3	45	5355-00-508-7937	2	15
	5	4	5950-00-510-7848	13	1
5905-00-228-6088	5	8	5355-00-512-5484	2	16
5935-00-233-6728	5	6		2	22
	13	13	5355-00-512-5485	2	18
5910-00-241-6513	6	21	5999-00-521-2411	6	7
	14	32		8	34
5905-00-246-9397	15	3	5305-00-531-0137	7	12
5905-00-252-1047	7	2		7A	11
	7A	1	5310-00-543-2739	3	64
5905-00-254-7101	6	55	5310-00-543-4652	7S	29
	6A	53	5310-00-550-3715	13	38
5935-00-255-9968	13	33		6A	66
5961-00-283-5608	14	4		7A	28
5920-00-284-7079	3	48	5340-00-550-8485	1	16
5920-00-284-9494	3	46	5920-00-556-0144	5	5
5340-00-286-6587	4	18	5920-00-568-0926	13	14
5920-00-296-0451	1	12	5910-00-569-7963	8	36
5935-00-296-7714	3	68	5310-00-595-6211	3	52
5910-00-344-1923	15	1		7	10
5905-00-359-6902	15	29		9	8
5962-00-369-7706	14	16		13	9
5905-00-400-4601	8	32		13	42
5961-00-401-3298	8	22		6A	67
5905-00-401-7444	6	40	5310-00-619-1148	1	19
	8	9	5905-00-644-6990	13	19
	6A	48	5905-00-660-4311	13	21
5940-00-405-2175	13	24	5910-00-678-8155	6	28
5961-00-409-1636	6	52	5910-00-681-7647	14	7
	6A	1	5910-00-682-0675	4	1
5961-00-420-4047	6	17		6	37
5905-00-431-5152	6A	49	5940-00-682-2477	3	75
5961-00-433-5808	14	10		9	16
5935-00-439-3733	11	15	5930-00-683-2814	4	11

NATIONAL STOCK NUMBER AND PART NUMBER INDEX

STOCK NUMBER	NATIONAL STOCK NUMBER INDEX		STOCK NUMBER	FIG.	ITEM
	FIG.	ITEM			
5305-00-701-5075	2	11	5310-00-933-8118	3	55
5910-00-712-6170	14	25		3	66
5910-00-717-0169	14	12		5	11
5310-00-722-5998	7A	8		6	68
5305-00-727-8832	4	17		9	
5305-00-727-8833	3	28		7A	7
5305-00-763-6963	1	22	5310-00-933-8120	1	18
	3	23		3	3
	3	31		3	61
5305-00-764-0068	3	58	5865-00-934-1272	4	15
5305-00-764-0070	6	65	5310-00-934-9748	3	71
5910-00-765-6316	14	13		7	11
5305-00-768-0336	3	35		13	4
5930-00-791-9607	13	22		13	7
5310-00-810-7785	7A	18		13	12
5910-00-822-8214	6	29		13	32
	14	30		6A	68
5940-00-827-2653	3	32	5310-00-934-9759	3	5
5935-00-835-0510	13	6		7	8
5910-00-835-2710	14	14	5905-00-935-8539	8	28
5910-00-835-2718	14	26		15	10
5910-00-835-2722	14	20	5905-00-935-8545	5A	4
5910-00-835-2726	14	18	5995-00-937-9393	3	79
5910-00-835-2734	14	21	5930-00-947-8318	13	25
5910-00-835-6855	14	22	5910-00-951-8618	14	23
5910-00-836-8902	14	17	5910-00-956-8317	14	1
5961-00-842-9864	6	61	5905-00-958-7193	13	18
	14	28	5935-00-960-3174	5	2
	6A	19	5310-00-973-8660	3	9
5910-00-845-7407	6	34	5310-00-982-4999	4	20
5910-00-850-7991	14	9	5910-00-983-5388	15	22
5905-00-874-0147	6	27	5905-00-993-2326	4	2
	6A	47	5305-00-993-9189	13	37
5310-00-880-5978	3	4	5305-00-995-6653	13	2
6680-00-891-0956	2	5	5910-01-009-7577	6	50
5961-00-892-0734	6	48		6A	2
	8	14	5340-01-013-4142	7	19
	11	10	5962-01-014-8081	6	45
	6A	16		6A	59
5961-00-902-1177	14	35	5905-01-016-8580	6	51
5910-00-903-9562	14	35	5970-01-023-5351	7A	14
6210-00-905-3725	2	20	5905-01-023-5829	8	44
	13	23	5961-01-023-7094	6	2
4730-00-908-6293	3	2		6A	33
5950-00-916-5515	14	33	5905-01-023-7575	6	22
5995-00-919-4683	1	3	5905-01-027-8077	11	13
5995-00-919-4684	1	5	6625-01-029-9024	3	13
5310-00-929-6395	3	10	5905-01-030-9745	11	3
6625-00-930-8296	3	1	5930-01-033-6022	13	20
5961-00-931-0372	14	36	5910-01-039-8150	8	21

NATIONAL STOCK NUMBER AND PART NUMBER INDEX

STOCK NUMBER	NATIONAL STOCK NUMBER INDEX		STOCK NUMBER	NATIONAL STOCK NUMBER INDEX	
	FIG.	ITEM		FIG.	ITEM
5962-01-044-5002	6	49	5905-01-091-1187	6	26
	6A	57		6A	42
5905-01-053-3956	8	46	5905-01-091-1188	7	1
5910-01-056-5015	8	37	5905-01-091-1189	5A	3
5940-01-061-1216	7A	22	5961-01-091-1387	6	57
5962-01-069-3045	6	31		6A	17
	8	4	5961-01-091-1388	6	54
	6A	60		10	6
5910-01-072-9503	11	1		11	16
6625-01-077-8577	1	3		6A	23
5962-01-083-0937	8	13	5935-01-091-1775	1	6
5950-01-086-3154	3	57	5935-01-091-1831	6	19
6625-01-086-3155	3	34		8	24
6625-01-086-3156	3	50	5935-01-091-1832	6	56
6625-01-086-3158	9	3	5935-01-091-1833	8	41
5930-01-086-3218	4	6	5930-01-091-3297	6	30
6125-01-086-4764	3	6		6A	61
5935-01-086-6850	6	32	5950-01-091-3436	11	8
	14	34	5905-01-091-3480	7	14
	6A	74		7A	5
5962-01-087-9508	6	46	5935-01-091-5397	2	21
	6A	58	5935-01-091-7975	3	33
6625-01-089-6947	3	56	5935-01-091-8597	3	77
5995-01-089-7626	1	4	5930-01-091-9444	5	1
5995-01-089-7627	1	10	5995-01-092-3309	7	21
5995-01-089-7628	4	23		7A	20
5995-01-089-7629	4	21	5905-01-092-6308	6A	39
5995-01-089-7630	4	28	5950-01-092-6414	6	42
5995-01-089-7631	4	25		6A	32
5995-01-089-7632	3	80	5905-01-092-9104	10	8
5995-01-089-8582	7	23	5930-01-092-9277	13	17
	7A	21	5930-01-092-9278	3	74
5995-01-089-8583	9	5	5961-01-092-9498	11	7
5995-01-089-8584	9	13	5935-01-092-9957	6	53
5935-01-090-3996	5A	1		8	20
6625-01-090-5335	2	2	5920-01-093-8458	8	35
6625-01-090-5336	4	22	5999-01-095-6265	1	7
5950-01-090-6278	9	2		3	76
6625-01-090-7646	11	9	5935-01-096-1872	3	39
5910-01-090-9390	6	66	5910-01-115-9699	14	6
	10	4	5910-01-121-1137	10	3
	11	6	5999-01-123-0558	8	25
5355-01-090-9648	2	7	5999-01-125-5949	6	74
5910-01-091-0104	6	23		6A	69
	11	11	5999-01-126-8351	6	71
	6A	7		8	16
5910-01-091-0113	7	5	5999-01-127-0664	8	27
	10	1	5975-01-129-4950	7A	19
	7A	4	5910-01-142-4994	6	38
5905-01-091-1186	7	7		6A	4

NATIONAL STOCK NUMBER AND PART NUMBER INDEX

STOCK NUMBER	NATIONAL STOCK NUMBER INDEX		FIG.	ITEM
	FIG.	ITEM		
6625-01-150-5256	3	16		
6625-01-150-5257	3	19		
6625-01-150-5259	6A	82		
6625-01-150-5260	3	73		
6625-01-150-5261	3	42		
6625-01-151-4210	3	15		
3439-01-152-2561	13	27		
5310-01-153-9187	4	10		
5305-01-154-0694	4	3		
5305-01-154-0695	3	22		
5305-01-154-0696	2A	4		
5310-01-154-0710	3	20		
	4	9		
5310-01-154-0726	4	4		
5310-01-154-0727	3	21		
5310-01-154-6015	4	5		
5305-01-154-6056	4	8		
5305-01-154-6060	4	16		
6625-01-154-7347	2	1		
6625-01-154-7367	3	44		
6625-01-154-7368	3	37		
5999-01-155-0890	6A	79		
5935-01-155-7474	6A	24		
5935-01-155-7475	6A	25		
5935-01-155-7476	6A	26		
5935-01-155-7477	6A	27		
5935-01-155-7478	6A	28		
5935-01-155-7479	6A	29		
5935-01-155-7480	6A	30		
5935-01-155-7481	6A	31		
5999-01-155-7968	8	38		
5905-01-156-5659	7A	25		
5999-01-172-8469	7	22		
	7A	3		
5920-01-173-7763	3	53		
5910-01-182-3260	8	23		
	11	5		
6625-01-189-1854	1	14		
6625-01-189-3009	13	28		
	13	45		
6625-01-189-6792	3	36		
6625-01-189-6793	6	72		
	6A	64		
6625-01-189-6794	7	4		
	7A	26		
6625-01-189-6795	2	9		
5910-01-190-1198	7	3		
5999-01-190-6558	13	29		
5999-01-190-6559	13	35		
5970-01-193-1779	5	9		

NATIONAL STOCK NUMBER AND PART NUMBER INDEX

FSCM	PART NUMBER	PART NUMBER INDEX STOCK NUMBER	FIG.	ITEM
16727	A0B254-2M	5910-00-023-9868	7	15
82199	A148079	6625-01-189-6795	2	9
82199	A148558		1	21
82199	A148559		2A	10
82199	A148690		3	2
82199	A148807	5865-00-934-1272	4	15
82199	A148998		2	4
82199	A149163		2A	2
			2A	9
82199	A149252	5995-00-937-9393	3	79
82199	A153211-2		1	17
82199	A155116		4	27
82199	A159411		4	13
82199	A160034	5960-00-011-9144	3	81
82199	A160359	6625-01-090-5336	4	22
82199	A161314	5950-01-091-3436	11	8
82199	A161417		4	26
82199	A161449B	5910-01-190-1198	7	3
82199	A161455	5970-01-193-1779	5	9
82199	A161456		3	41
82199	A161457-1	5910-01-090-9390	6	66
			10	4
			11	6
82199	A161459	6625-01-189-6792	3	36
82199	A161461		6	64
82199	A161461-1		6A	84
82199	A161462	5950-01-092-6414	6	42
			6A	32
82199	A161463		6	75
82199	A161467		7	6
			7A	12
82199	A161468		6	63
82199	A161474		6	77
			6A	76
82199	A161479		4	29
82199	A161517	6625-01-189-6793	6	72
			6A	64
91833	A161906	5920-01-173-7763	3	53
82199	A165693	3439-01-152-2561	13	27
82199	A165931-1		1	8
82199	A165931-2		1	9
82199	A165995	5930-01-092-9277	13	17
82199	A167156-1		5A	6
82199	A710396		2A	3
			2A	8
11236	BA30397	5905-00-660-4311	13	21
82199	BP12551	5995-00-919-4683	1	13
82199	BP12553	5995-00-919-4684	1	5
82199	B148270		2	23
82199	B148560		1	23
82199	B148612	6625-01-154-7368	3	37

NATIONAL STOCK NUMBER AND PART NUMBER INDEX

FSCM	PART NUMBER	PART NUMBER INDEX		FIG.	ITEM
		STOCK NUMBER			
82199	B148809			4	7
82199	B159494			2	3
82199	B159495			2	8
82199	B160826	5995-01-089-7626		1	4
82199	B160833	5995-01-089-7627		1	10
82199	B161311	6625-01-090-5335		2	2
82199	B161316	5930-01-091-3297		6	30
				6A	61
82199	B161433	6625-01-189-6794		7	4
				7A	26
				11	17
82199	B161440			9	3
82199	B161444	6625-01-086-3158		3	40
82199	B161445			7	22
82199	B161446	5999-01-172-8469		3	24
82199	B161447			7A	19
82199	B161453-1	5975-01-129-4950		3	11
82199	B161460			6	62
82199	B161486			9	5
82199	B161490	5995-01-089-8583		9	13
82199	B161491	5995-01-089-8584		2A	7
82199	B161497			4	23
82199	B161503	5995-01-089-7628		4	25
82199	B161505	5995-01-089-7631		3	56
82199	B161506	6625-01-089-6947		2	21
82199	B161509	5935-01-091-5397		7	13
82199	B161513			7A	10
				4	24
82199	B161514			7	23
82199	B161515	5995-01-089-8582		7A	21
				7	21
82199	B161516	5995-01-092-3309		7A	20
				4	28
82199	B161526	5995-01-089-7630		3	80
82199	B161527	5995-01-089-7632		3	29
82199	B161528			3	7
82199	B161529			5	1
82199	B161546	5930-01-091-9444		6A	75
82199	B161571			6A	81
82199	B161572			6A	70
82199	B161573			6A	83
82199	B161609			6A	79
82199	B161742	5999-01-155-0890		7A	3
82199	B162078	5999-01-172-8469		14	38
82199	B165832			13	1
82199	B165928	5950-00-510-7848		13	36
82199	B165930			3	1
82199	B702227	6625-00-930-8296		2	6
82199	B713439	5355-00-172-2466		12	5
49671	CA3130S			11	3
75042	CGH2-105F	5905-01-030-9745		6	34
81349	CK60AX331K	5910-00-845-7407			

NATIONAL STOCK NUMBER AND PART NUMBER INDEX

FSCM	PART NUMBER	PART NUMBER INDEX	
		STOCK NUMBER	FIG. ITEM
81349	CK60BX100K	5910-00-983-5388	15 22
81349	CK60BX470K	5910-00-822-8214	6 29
			14 30
81349	CMR05F910G0DR	5910-01-056-5015	8 37
81349	CM15ED470GP3	5910-00-138-6964	14 24
81349	CM15E910J	5910-00-951-8618	14 23
81349	CM15FD101G03	5910-00-717-0169	14 12
81349	CM15FD151G03	5910-00-850-7991	14 9
81349	CM30E122J	5910-00-765-6316	14 13
81349	CM30FD202G03	5910-00-712-6170	14 25
81349	CTM103VAJ	5910-00-835-2710	14 14
81349	CTM104VAJ	5910-00-835-2734	14 21
81349	CTM223VAJ	5910-00-835-2718	14 26
81349	CTM332VBJ	5910-00-835-6855	14 22
81349	CTM333VAJ	5910-00-835-2722	14 20
81349	CTM393VAJ	5910-00-836-8902	14 14
91637	CW-2C-1		12 16
82199	C147363	6625-01-189-1854	1 14
82199	C160023	5930-01-086-3218	4 6
82199	C160850	6625-01-029-9024	3 13
82199	C160851	5995-01-089-7629	4 21
82199	C161301		7 25
82877	C161312(J)		3 62
82199	C161313	5950-01-090-6278	9 2
82199	C161319		8 43
82199	C161321	6625-01-086-3156	3 50
82199	C161419-1		9 4
82199	C161419-2		9 11
82199	C161439		10 9
82199	C161443-2		9 1
82199	C161450		9 15
82199	C161451		3 17
82199	C161454	5950-01-086-3154	3 57
82199	C161454(E)		3 57
82199	C161493	6625-01-154-7367	3 44
82199	C161496		2 10
82199	C161521	6625-01-150-5260	3 73
82199	C161525		5 13
82199	C161530	6625-01-151-4210	3 15
82199	C161530-1	6625-01-150-5257	3 19
82199	C162191-1	5935-01-155-7474	6A 24
82199	C162191-12	5935-01-155-7476	6A 26
82199	C162191-2	5935-01-155-7475	6A 25
82199	C162191-4	5935-01-155-7481	6A 31
82199	C162191-6	5935-01-155-7477	6A 27
82199	C162191-7	5935-01-155-7479	6A 29
82199	C162191-8	5935-01-155-7480	6A 30
82199	C162191-9	5935-01-155-7478	6A 28
82199	C166601		13 44
82199	C167141	6125-01-086-4764	3 6
82199	C167141-1		12 25

NATIONAL STOCK NUMBER AND PART NUMBER INDEX

FSCM	PART NUMBER	PART NUMBER INDEX	
		STOCK NUMBER	FIG. ITEM
82199	C167156	6625-01-150-5256	3 16
73445	C280AE/A100K	5910-00-071-9922	8 5
78553	C61254AA015		3 30
			7 26
78553	C61255AA015	5340-01-013-4142	7 19
95238	C7-20SVRNGD	5935-00-960-3174	5 2
78553	C8103-832		3 67
71590	DD-271	5910-00-678-8155	6 28
71590	DD101		12 4
71590	DD102	5910-00-241-6513	6 21
			14 32
			6A 8
14655	DD16-153		6A 14
14655	DD30-220		6A 13
71590	DD330	5910-00-344-1923	15 1
14655	DD331		6A 6
14655	DD470		6A 9
71590	DD6-103		13 26
82199	D161309	6625-01-150-5261	3 42
82199	D161424-1		3 18
			3 59
82199	D161469-1	6625-01-086-3155	3 34
82199	D161523	6625-01-154-7347	2 1
82199	D161808-1	6625-01-150-5259	6A 82
82199	D165834	6625-01-189-3009	13 28
			13 45
09214	D40D7	5961-01-023-7094	6A 33
03508	D40E7	5961-01-023-7094	6 2
83701	EG300	5961-01-091-1387	6 57
			6A 17
82199	E161407		3 82
81349	F02A250V1/4A	5920-00-043-2641	1 11
			3 47
			8 33
			13 8
81349	F02A250V1/8A	5920-00-296-0451	1 12
81349	F02A250V2-1-2A	5920-01-093-8458	8 35
81349	F02A250V3-4AS	5920-00-284-9494	3 46
81349	F02B250V1-1/2A	5920-00-227-6179	3 45
			5 4
81349	JAN1N3191		12 12
81349	JAN1N4467	5961-00-147-9600	6 58
			8 8
			12 8
			6A 15
81349	JAN1N4476	5961-00-098-8669	11 4
			6A 21
81349	JAN1N4477	5961-00-283-5608	14 4
81349	JAN1N914	5961-00-842-9864	6 61
			14 28
			6A 19

NATIONAL STOCK NUMBER AND PART NUMBER INDEX

FSCM	PART NUMBER	PART NUMBER INDEX STOCK NUMBER	FIG.	ITEM
81349	JAN2N3584		12	19
81349	JAN2N3904		14	2
81349	JAN2N5416	5961-00-443-9747	6	6
			6A	34
81349	JAN2N5998	5961-01-092-9498	11	7
81349	JAN2N6211		12	17
81349	JAN2N6219		12	3
91929	JV5-42		4	12
04713	MC78M20CT	5962-01-083-0937	8	13
80058	MD-1075/URM	6625-01-077-8577	1	3
04713	MDA920A3		8	18
			10	5
			14	3
04713	MDA970A1	5961-00-409-1636	6	52
			6A	1
96906	MS15795-803	5310-00-595-6211	3	52
			7	10
			9	8
			12	22
			13	9
			13	42
			6A	67
96906	MS15795-805	5310-00-722-5998	7A	8
96906	MS15795-807	5310-00-880-5978	3	4
96906	MS21044B06		13	41
96906	MS21044C04	5310-00-982-4999	4	20
81349	MS21044C3	5310-00-208-9255	2	12
96906	MS24693C2	5305-00-993-9189	13	37
96906	MS25253-1	5930-00-683-2814	4	11
96906	MS35190-222	5305-00-995-6653	13	2
96906	MS35330-70		7	9
			13	3
			13	11
			13	31
			13	43
			2A	5
96906	MS35333-69	5310-00-543-4652	7A	29
96906	MS35333-70	5310-00-550-3715	13	38
			6A	66
			7A	28
96906	MS35333-72	5310-00-543-2739	3	64
96906	MS35335-57		12	21
96906	MS35338-135	5310-00-933-8118	3	55
			3	66
			5	11
			6	68
			9	7
			7A	7
96906	MS35338-136	5310-00-929-6395	3	10
96906	MS35338-137		3	26
			7	17

NATIONAL STOCK NUMBER AND PART NUMBER INDEX

FSCM	PART NUMBER	PART NUMBER INDEX STOCK NUMBER	FIG.	ITEM
96906	MS35338-138	5310-00-933-8120	1	18
			3	3
			3	61
96906	MS35649-244	5310-00-934-9748	3	71
			7	11
			12	23
			13	4
			13	7
			13	12
			13	32
			6A	68
96906	MS35649-284	5310-00-934-9759	3	5
			7	18
96906	MS35650-244		5	12
96906	MS35842-15	4730-00-908-6293	3	12
96906	MS51021-21	5305-00-531-0137	7	12
			7A	11
96906	MS519057-14		12	20
96906	MS51957-14	5305-00-054-5648	3	14
			7	8
			9	12
			13	30
			6A	85
96906	MS51957-15	5305-00-054-5649	3	51
			6	10
			13	10
			6A	65
96906	MS51957-16	5305-00-054-5650	4	31
			5	7
			7A	15
96906	MS51957-17	5305-00-054-5651	7	24
96906	MS51957-19		1	15
			3	27
			3	54
			5	10
			6	5
			6	65
			9	6
			13	6
			13	15
			6A	72
			7A	6
96906	MS51957-25	5305-00-054-6649	3	38
96906	MS51957-26	5305-00-054-6650	3	78
96906	MS51957-27	5305-00-054-6651	13	34
			13	40
96906	MS51957-29	5305-00-054-6653	2	17
96906	MS51957-3	5305-00-054-5637	7	20
			7A	27
96906	MS51957-30	5305-00-054-6654	3	8
			3	70

NATIONAL STOCK NUMBER AND PART NUMBER INDEX

FSCM	PART NUMBER	PART NUMBER INDEX		FIG.	ITEM
		STOCK NUMBER			
96906	MS51957-43	5305-00-054-6668		6	69
96906	MS51957-45	5305-00-054-6670		3	63
96906	MS51957-46			7	16
96906	MS51957-47	5305-00-054-6672		3	25
96906	MS51957-51	5305-00-054-6676		4	19
96906	MS51958-67	5305-00-059-3663		1	20
96906	MS51958-68	5305-00-059-3664		3	60
96906	MS51959-17	5305-00-768-0336		3	35
96906	MS51959-28	5305-00-763-6963		1	22
				3	23
				3	31
96906	MS51959-29	5305-00-727-8832		4	17
96906	MS51959-3	5305-00-727-8833		3	28
96906	MS51959-45	5305-00-764-0068		3	58
96906	MS51959-46	5305-00-764-0070		3	65
96906	MS51959-64	5305-00-701-5075		2	11
96906	MS75029-23	5930-00-947-8318		13	25
96906	MS77068-1	5940-00-682-2477		3	75
				9	16
96906	MS77068-2	5940-00-827-2653		3	32
81349	M38510/01201BCB	5962-00-369-7706		14	16
81349	M38510/05101BCB	5962-01-014-8081		6	45
				6A	59
81349	M38510/10901BPB	5962-01-069-3045		6	31
				8	4
				6A	60
81349	M39003/01-3003	5910-00-007-2002		14	15
81349	M39012/21-0001	5935-00-835-0510		13	16
81349	M39018/01-1036M	5910-01-115-9699		14	6
81312	M4PLSH10C	5935-00-296-7714		3	68
81312	M4S-LRN	5935-00-498-4733		5	8
80205	NAS671-4	5310-00-810-7785		7A	18
71590	PA1021	5930-00-791-9607		13	22
73445	PMG-10002A			6A	3
73445	PMG1001-A			6A	11
73445	PMG1002A			6	24
75042	PQ11-120	5905-00-644-6990		13	19
75042	PQ11-123	5905-00-958-7193		13	18
81349	RCR07G104JS			12	6
81349	RCR07G563JS			12	11
81349	RCR07G622JS			12	1
81349	RCR20G100JS	5905-00-104-5755		15	6
81349	RCR20G101JS	5905-00-106-9344		15	7
81349	RCR20G102JS	5905-00-110-0196		6	47
				8	3
				15	13
				6A	51
81349	RCR20G103JS			6	20
				8	1
				15	25
				6A	44

NATIONAL STOCK NUMBER AND PART NUMBER INDEX

FSCM	PART NUMBER	PART NUMBER INDEX		FIG.	ITEM
		STOCK NUMBER			
81349	RCR20G104JS	5905-00-104-8336		6	14
				15	2
				6A	36
81349	RCR20G105JS	5905-00-104-5756		6	18
				6A	37
81349	RCR20G122JS	5905-00-141-0592		8	17
				15	12
81349	RCR20G151JS	5905-00-108-6922		8	26
81349	RCR20G152JS	5905-00-111-4738		6	60
				15	9
81349	RCR20G153JS	5905-00-106-1273		6	1
				15	14
				6A	55
81349	RCR20G182JS	5905-00-141-0593		15	15
81349	RCR20G183JS	5905-00-935-8545		5A	4
81349	RCR20G201JS	5905-00-141-0727		8	19
81349	RCR20G202JS	5905-00-935-8539		8	28
				15	10
81349	RCR20G204JS	5905-00-116-8560		15	18
81349	RCR20G221JS	5905-00-104-8350		15	17
81349	RCR20G222JS	5905-00-141-1168		15	23
81349	RCR20G224JS	5905-00-114-5393		6	59
				6A	45
81349	RCR20G271JS	5905-00-114-5407		8	31
				6A	50
				15	31
81349	RCR20G272JS	5905-00-141-1130		6	25
81349	RCR20G274JS	5905-00-114-5416		10	2
				6A	43
81349	RCR20G332JS	5905-00-104-8348		15	20
81349	RCR20G391JS	5905-00-111-4742		15	21
81349	RCR20G392JS	5905-00-110-0310		6	12
				15	16
81349	RCR20G393JS	5905-00-141-0599		6A	54
				6	11
				15	26
81349	RCR20G4R7JS	5905-00-126-6705		6A	52
81349	RCR20G471JS	5905-00-111-4858		14	37
				11	2
81349	RCR20G472JS	5905-00-141-0595		15	27
81349	RCR20G473JS	5905-00-141-0596		15	5
81349	RCR20G474JS	5905-00-141-1071		15	30
				6	39
81349	RCR20G475JS	5905-00-104-8332		15	28
				6A	40
				8	6
81349	RCR20G510JS	5905-00-114-5438		15	19
81349	RCR20G513JS	5905-00-141-0597		15	24
81349	RCR20G560JS	5905-00-104-8345		15	34
81349	RCR20G565JS	5905-00-246-9397		15	3
81349	RCR20G621JS	5905-00-141-0723		6	9

NATIONAL STOCK NUMBER AND PART NUMBER INDEX

FSCM	PART NUMBER	PART NUMBER INDEX		FIG.	ITEM
		STOCK NUMBER			
81349	RCR20G681JS	5905-00-111-8357		15	32
81349	RCR20G682JS	5905-00-141-1165		15	4
81349	RCR20G68566			15	33
81349	RCR20G911JS	5905-00-106-1274		15	11
81349	RCR32G104JS	5905-00-106-1276		6	36
				6A	41
81349	RCR32G150JS	5905-00-400-4601		8	32
81349	RCR32G274JS	5905-00-252-1047		7	2
				7A	1
81349	RCR32G275JS	5905-00-484-0275		6A	56
81349	RCR32G331JS	5905-00-228-6088		15	8
81349	RCR42G102JS	5905-00-138-4927		6	13
				6A	38
81349	RCR42G473JS	5905-00-874-0147		6	27
				6A	47
81349	RC42GF104J	5905-00-254-7101		6	55
				6A	53
81349	RNC55H2612FS	5905-00-431-5152		6A	49
81349	RNC65H1002FS	5905-00-401-7444		6	40
				8	9
				6A	48
81349	RNC65H2612FS	5905-00-147-9844		6	41
81349	RNC65H5621FS	5905-00-482-0791		8	10
81349	RWR74S1002FR			12	10
81349	RWR80SR200FS			8	30
81349	RW69V471	5905-00-088-0635		11	12
80058	SG-1145/URM			1	2
14099	SH30F	5961-01-091-1388		6	54
				10	6
				11	16
				6A	23
80063	SM-B-416109-1	5310-00-973-8660		3	9
80063	SM-B-603975	5940-00-405-2175		13	24
01295	SN72741L			11	14
56289	TE1305-5	5910-00-163-4071		14	8
56289	TVA1102	5910-00-681-7647		14	7
56289	TVA1442.3			12	13
70892	T120-11			4	14
13715	UA4001			12	24
13715	UA4018			12	2
34148	UA78GU1C	5962-01-044-5002		6	49
				6A	57
71450	U201R194B			15	35
71450	U201R253B	5905-00-359-6902		15	29
34148	U5R7723312			8	11
90201	VTL330S50	5910-01-142-4994		6	38
				6A	4
14655	WBR12-450	5910-01-091-0113		7	5
				10	1
				7A	4
14655	WMF1P22	5910-00-903-9562		14	27

NATIONAL STOCK NUMBER AND PART NUMBER INDEX

FSCM	PART NUMBER	PART NUMBER INDEX		FIG.	ITEM
		STOCK NUMBER			
14655	WMF1S18J	5910-00-463-8046		14	19
14655	WMF1S47	5910-00-835-2726		14	18
84411	X463UW			6A	10
82199	005033	5905-00-993-2326		4	2
06424	0770-9	5310-00-619-1148		1	19
00779	1-480698-0	5935-01-096-1872		3	39
00779	1-480702-0	5935-01-091-7975		3	33
00779	1-480704-0	5935-01-091-1775		1	6
84171	1MW103			12	9
81349	1N456	5961-00-892-0734		6	48
				8	14
				11	10
				6A	16
80131	1N4759A	5961-00-499-7909		6	35
				6A	18
80131	1N4762A	5961-00-079-6881		6	16
				6A	22
80131	1N5233B	5961-00-444-6607		14	5
81349	1N5240B			14	31
04713	1N5382B	5961-00-420-4047		6	17
				6A	20
56289	10PS-P10	5910-01-072-9503		11	1
16845	1000-483-23			12	14
75915	102074	5999-00-521-2411		6	7
				8	34
71279	1028-1			8	45
56289	105X0035CD2			12	7
13103	1116B	5999-01-125-5949		6	74
				6A	69
83330	120			3	72
91833	1253			6	3
				12	18
				7A	23
71785	133-98-92-061	5935-00-439-3733		11	15
71450	13604-1	5930-01-033-6022		13	20
56289	16PS-S50	5910-01-091-0104		6	23
				11	11
				6A	7
56289	162D0106X9020DD2			8	7
16428	17252	5935-00-233-6728		5	6
				13	13
00779	2-350800-2	5940-01-061-1216		7A	22
13688	2N2646	5961-00-902-1177		14	35
80131	2N3906	5961-00-931-0372		14	36
27622	2N4304	5961-00-477-1248		14	29
34148	2N4400	5961-00-433-5808		14	10
80131	2N4402	5961-00-450-3040		8	29
				14	11
80131	2N5190	5961-00-401-3298		8	22
71590	20BE	5930-01-092-9278		3	74
97046	201CB	5999-01-190-6558		13	29

NATIONAL STOCK NUMBER AND PART NUMBER INDEX

FSCM	PART NUMBER	PART NUMBER INDEX STOCK NUMBER	FIG.	ITEM
83330	2175		9	10
83330	2193	5340-00-550-8485	1	16
01614	22		3	43
44655	23J1K0	5905-01-092-6308	6A	39
73734	23021		9	9
18677	23071-2		9	14
06540	2363PH163	5970-01-023-5351	7A	14
96795	243037-257	5910-00-956-8317	14	1
97046	292AP	5999-01-190-6559	13	35
95987	3/16-6	5340-00-286-6587	4	18
56289	30D256G050CC2	5910-00-463-9490	6	43
			6A	5
00213	3005-100-3W	5905-01-092-9104	10	8
75915	312.031	5920-00-122-0315	3	49
			6	8
75915	31202.5	5920-00-284-7079	3	48
91506	314-AG39D	5935-01-086-6850	14	34
91506	314AG39D	5935-01-086-6850	6	32
			6A	74
95263	32-1111T	6210-00-905-3725	2	20
			13	23
89536	325720	5961-00-497-4280	8	15
71785	332-14-08-042	5940-00-192-9962	13	46
80294	3339H-L-204		6	15
80294	3339H-1-102	5905-01-053-3956	8	46
80294	3339H-1-203	5905-01-027-8077	11	13
32997	3339H-1-501	5905-01-023-5829	8	44
32997	3339H-1-502	5905-01-023-7575	6	22
75915	341001	5920-00-568-0926	13	14
71400	342004	5920-00-556-0144	5	5
55680	35U10	5910-00-569-7963	8	36
00779	350428-1	5935-01-091-1831	6	19
			8	24
00779	350430-1	5935-01-091-1832	6	56
00779	350431-1		8	39
			5A	5
00779	350689-1	5999-01-095-6265	1	7
			3	76
00779	350711-1	5935-01-091-1833	8	41
00779	350771-1	5935-01-091-8597	3	77
00779	350786-1	5935-01-092-9957	6	53
			8	20
00779	350792-1/RED/	5935-01-090-3996	5A	1
83330	379BLACK		2A	1
00799	380-635-2	6625-01-090-7646	11	9
18911	4D8861RCL	6680-00-891-0956	2	5
49671	40312	5961-00-078-6727	13	39
91833	4615	5935-00-255-9968	13	33
82389	46206LFR	5930-00-043-1378	5	3
			13	5
76493	4652	5950-00-916-5515	14	33

NATIONAL STOCK NUMBER AND PART NUMBER INDEX

FSCM	PART NUMBER	PART NUMBER INDEX		FIG.	ITEM
		STOCK NUMBER			
23480	5CC1B2	5355-00-508-7937		2	15
23480	5CC2B2	5355-00-512-5484		2	16
				2	22
23480	5PC2B2	5355-00-512-5485		2	18
63743	5XM180WL	5905-00-483-7415		8	12
82199	502823	5310-01-154-6015		4	5
56289	503D107G0			10	7
56289	503D107M025ML			8	2
56289	503D108G016ER	5910-01-009-7577		6	50
				6A	2
56289	503D226M050LA			8	40
56289	503D477F050QG	5910-01-121-1137		10	3
56289	503D477M063QE	5910-01-182-3260		8	23
				11	5
82199	503603	5310-01-154-0710		3	20
				4	9
82199	512428	5305-01-154-0694		4	3
82199	512447	5305-01-154-6056		4	8
82199	513223	5305-01-154-6060		4	16
82199	515903	5310-01-154-0727		3	21
83330	52-1505			7A	9
82199	520803	5310-01-154-0726		4	4
82199	520804	5310-01-153-9187		4	10
82199	531727	5305-01-154-0695		3	22
82199	531730	5305-01-154-0696		2A	4
80183	60GA-D47	5910-00-682-0675		4	1
				6	37
13103	6030B	5999-01-126-8351		6	71
				8	16
13103	60308			6A	63
13103	6063B	5999-01-155-7968		8	38
13103	6071B	599-01-123-0558		8	25
13103	6072B	5999-01-127-0664		8	27
84411	663UW			6	44
01121	70B1N048F103W	5905-01-091-1188		7	1
01121	70B1N048103W			7A	2
01121	70B1N056P104W	5905-01-091-1186		7	7
01121	70B5N056P104W	5905-01-156-5659		7A	25
01121	70D1N048F253W	5905-01-091-3480		7	14
				7A	5
01121	70N1M032S104W	5905-01-091-1189		5A	3
01121	70N1M032S254W			5A	2
73138	72PR5K	5905-01-016-8580		6	51
73138	72P254	5905-01-091-1187		6	26
				6A	42
73138	72P5K0HM			6A	35
56699	8F556M1	5910-01-039-8150		8	21
91506	8058-1G23			6	4
91506	8058-24G1	5935-00-111-8546		8	42
07148	80787-1	5962-01-087-9508		6	46
				6A	58

NATIONAL STOCK NUMBER AND PART NUMBER INDEX

FSCM	PART NUMBER	PART NUMBER INDEX STOCK NUMBER	FIG.	ITEM
72982	811-000-2540-103		6A	12
72982	811-000-2540-103 M		6	33
06540	8166PH0440		6A	73
06540	8217A0440		6A	73
06540	8217A440		6	76
06540	8582B0832-3A		6	67
06540	8592B0832-3A		6	70
83330	872		2A	6
23480	9EC2B2	5355-01-090-9648	2	7
80249	910638-11		12	15
06540	9326B194-4		4	30

By Order of the Secretary of the Army:

JOHN A. WICKHAM JR.
General, United States Army
Chief of Staff

Official:

DONALD J. DELANDRO
Brigadier General, United States Army
The Adjutant General

DISTRIBUTION:

To be distributed in accordance with DA Form 12-36 literature requirements for AN/URM-206.

RECOMMENDED CHANGES TO EQUIPMENT TECHNICAL PUBLICATIONS



SOMETHING WRONG WITH THIS PUBLICATION?

THEN... JOT DOWN THE DOPE ABOUT IT ON THIS FORM. CAREFULLY TEAR IT OUT. FOLD IT AND DROP IT IN THE MAIL!

FROM: (PRINT YOUR UNIT'S COMPLETE ADDRESS)
 Commander
 Stateside Army Depot
 ATTN: AMSTA-US
 Stateside, N.J. 07703-5007

DATE SENT
 10 July 1975

PUBLICATION NUMBER TM 11-5840-340-20P	PUBLICATION DATE 23 Jan 78	PUBLICATION TITLE Radar Set AN/PRC-76
--	-------------------------------	--

BE EXACT PIN-POINT WHERE IT IS				IN THIS SPACE TELL WHAT IS WRONG AND WHAT SHOULD BE DONE ABOUT IT:
PAGE NO	PARA-GRAPH	FIGURE NO	TABLE NO	
33				For item 2, change the NSN to read: 5835-00-134-9186. Reason: Accuracy.
44		19		Identify the cover on the junction box (item no. 5). Reason: It is a separate item and is not called out on figure 19.
45				Add the cover of the junction box as an item in the listing for figure 19. Reason: Same as above

S
A
M
P
L
E

PRINTED NAME, GRADE OR TITLE, AND TELEPHONE NUMBER
 SSG I. M. DeSpirit of 999-1776

SIGN HERE

TEAR ALONG PERFORATED LINE

FILL IN YOUR
UNIT'S ADDRESS

FOLD BACK

DEPARTMENT OF THE ARMY

OFFICIAL BUSINESS

SAMPLE

Commander
US Army Communications-Electronics
Command and Fort Monmouth
ATTN: AMSEL-ME-MP
Fort Monmouth, NJ 07703-5007

TEAR ALONG PERFORATED LINE

RECOMMENDED CHANGES TO EQUIPMENT TECHNICAL PUBLICATIONS



THEN...JOT DOWN THE DOPE ABOUT IT ON THIS FORM. CAREFULLY TEAR IT OUT, FOLD IT AND DROP IT IN THE MAIL.

SOMETHING WRONG WITH THIS PUBLICATION?

FROM: (PRINT YOUR UNIT'S COMPLETE ADDRESS)

DATE SENT

PUBLICATION NUMBER

TM 11-6625-2948-24P

PUBLICATION DATE

2 May 1985

PUBLICATION TITLE

Signal Generator AN/URM-206

BE EXACT PIN-POINT WHERE IT IS

PAGE NO.

PARA-GRAPH

FIGURE NO.

TABLE NO.

IN THIS SPACE TELL WHAT IS WRONG AND WHAT SHOULD BE DONE ABOUT IT:

TEAR ALONG PERFORATED LINE

PRINTED NAME GRADE OR TITLE AND TELEPHONE NUMBER

SIGN HERE

DA FORM 2028-2 JUL 79

PREVIOUS EDITIONS ARE OBSOLETE

P.S.--IF YOUR OUTFIT WANTS TO KNOW ABOUT YOUR RECOMMENDATION MAKE A CARBON COPE OF THIS AND GIVE IT TO YOUR HEADQUARTERS.

FILL IN YOUR
UNIT'S ADDRESS



FOLD BACK

DEPARTMENT OF THE ARMY

OFFICIAL BUSINESS

Commander
US Army Communications-Electronics
Command and Fort Monmouth
ATTN: AMSEL-ME-MP
Fort Monmouth, NJ 07703-5007

TEAR ALONG PERFORATED LINE

RECOMMENDED CHANGES TO EQUIPMENT TECHNICAL PUBLICATIONS



THEN...JOT DOWN THE DOPE ABOUT IT ON THIS FORM. CAREFULLY TEAR IT OUT, FOLD IT AND DROP IT IN THE MAIL.

SOMETHING WRONG WITH THIS PUBLICATION?

FROM: (PRINT YOUR UNIT'S COMPLETE ADDRESS)

DATE SENT

PUBLICATION NUMBER

TM 11-6625-2948-24P

PUBLICATION DATE

2 May 1985

PUBLICATION TITLE

Signal Generator AN/URM-206

BE EXACT PIN-POINT WHERE IT IS

PAGE NO.	PARA-GRAPH	FIGURE NO.	TABLE NO.

IN THIS SPACE TELL WHAT IS WRONG AND WHAT SHOULD BE DONE ABOUT IT:

TEAR ALONG PERFORATED LINE

PRINTED NAME GRADE OR TITLE AND TELEPHONE NUMBER

SIGN HERE

DA FORM 2028-2
1 JUL 79

PREVIOUS EDITIONS ARE OBSOLETE

P.S.--IF YOUR OUTFIT WANTS TO KNOW ABOUT YOUR RECOMMENDATION MAKE A CARBON COPE OF THIS AND GIVE IT TO YOUR HEADQUARTERS.

FILL IN YOUR
UNIT'S ADDRESS

FOLD BACK

DEPARTMENT OF THE ARMY

OFFICIAL BUSINESS

Commander
US Army Communications-Electronics
Command and Fort Monmouth
ATTN: AMSEL-ME-MP
Fort Monmouth, NJ 07703-5007

TEAR ALONG PERFORATED LINE

RECOMMENDED CHANGES TO EQUIPMENT TECHNICAL PUBLICATIONS

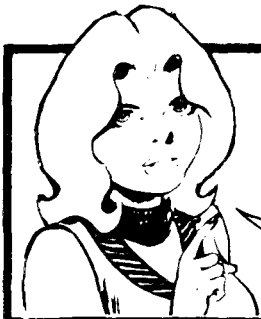

SOMETHING WRONG WITH THIS PUBLICATION?

THEN...JOT DOWN THE DOPE ABOUT IT ON THIS FORM. CAREFULLY TEAR IT OUT, FOLD IT AND DROP IT IN THE MAIL.

FROM: (PRINT YOUR UNIT'S COMPLETE ADDRESS)

DATE SENT

PUBLICATION NUMBER

TM 11-6625-2948-24P

PUBLICATION DATE

2 May 1985

PUBLICATION TITLE

Signal Generator AN/URM-206

BE EXACT PIN-POINT WHERE IT IS

PAGE NO.	PARA-GRAPH	FIGURE NO.	TABLE NO.
----------	------------	------------	-----------

IN THIS SPACE TELL WHAT IS WRONG AND WHAT SHOULD BE DONE ABOUT IT:

TEAR ALONG PERFORATED LINE

PRINTED NAME GRADE OR TITLE AND TELEPHONE NUMBER

SIGN HERE

DA FORM 2028-2
JUL 79

PREVIOUS EDITIONS ARE OBSOLETE

P.S.--IF YOUR OUTFIT WANTS TO KNOW ABOUT YOUR RECOMMENDATION MAKE A CARBON COPE OF THIS AND GIVE IT TO YOUR HEADQUARTERS.

FILL IN YOUR
UNIT'S ADDRESS



FOLD BACK

DEPARTMENT OF THE ARMY

OFFICIAL BUSINESS

Commander
US Army Communications-Electronics
Command and Fort Monmouth
ATTN: AMSEL-ME-MP
Fort Monmouth, NJ 07703-5007

TEAR ALONG PERFORATED LINE

